

LEAD WORKER CERTIFICATION TRAINING PROGRAM

STUDENT MANUAL



ENVIRONMENTAL EDUCATION ASSOCIATES

888 4 ENV EDU *environmentaleducation.com*



EPA Model Worker Course

RESIDENTIAL LEAD-BASED PAINT ABATEMENT

Student Manual

Produced under EPA Contract #68-W01-033

by
SPS Technologies, Inc.
March 2004 edition

Office of Pollution Prevention and Toxics
U.S. Environmental Protection Agency
Washington, DC 20460

Produced by
SPS Technologies, Inc.
211 Perry Parkway, Suite 4
Gaithersburg, Maryland 20877
301-926-7726
Fax 301-926-7724

Subcontractor
Georgia Tech Research Institute
Safety, Health and Environmental Technology Division
151 6th Street, O'Keefe Building
Atlanta, Georgia 30332-0837
404-894-3806
Fax 404-894-8275

Material contained in this publication is in the public domain.

It may be reproduced without permission of the federal government. Information contained in this curriculum may be reprinted in full or in part, or freely quoted, if this page is included as a means of crediting resources. This manual is not intended as an interpretation of EPA or OSHA regulations.

The mention of trade names, commercial products or organizations does not imply endorsement by the Environmental Protection Agency or by the U.S. Government.

LEAD ABATEMENT FOR WORKERS

TABLE OF CONTENTS

Course Overview	i
What is lead? Where is it found?	1
Health Effects: How Lead Affects The Body	2
Laws, Regulations, Standards	3
Identifying Lead-based Paint Hazards	4
Controlling Lead-based Paint Hazards	5
Setup	6
Abatement Methods	7
Cleanup, Disposal, and Clearance	8
Soil Abatement and Exterior Dust Cleanup	9
Glossary and Resources	10
Appendix A	



COURSE OVERVIEW

Course purpose	1-iii
Differences in training requirements	1-iii
Course introduction	1-iv
How to use this manual	1-v
Regulations or guidelines?	1-v
Abbreviations and units of measure	1-vi
Glossary and resources	1-vi
Learning objectives	1-vii
Pull quotes	1-vii
Key facts	1-vii





Course purpose

This course is designed to train workers to abate lead-based paint hazards safely. Your employer and job supervisor have provided this training for you for a number of reasons:

- to comply with EPA or state/Indian tribe training, accreditation, and licensing requirements;
- to provide you with the knowledge to do your job properly and safely;
- to train you in the laws and practices that apply to lead-based paint hazard control projects.

This course is designed to meet the requirements of 40 CFR Part 745—Lead; Requirements for Lead-based Paint Activities in Target Housing and Child-Occupied Facilities, a federal regulation under section 402 of the Toxic Substances Control Act (TSCA). It also meets the training requirements of HUD’s Lead-Safe Housing rule (24 CFR Part 35, et al.) for renovation, maintenance, and remodeling workers who disturb lead.

This course is not designed to meet the training requirements established under OSHA’s Interim Final: Lead in Construction standard (29 CFR 1926.62).

Differences in training requirements

EPA or your state/Indian tribe requires the use of trained and certified lead-based paint abatement workers when conducting abatement activities in housing or buildings where children spend a lot of time (the specific requirements will be explained during the regulations discussion of this course). OSHA requires annual training for all workers who are exposed to lead at or above the action limit established in the OSHA lead in construction standard. The state/Indian tribe in which you work may also have requirements in addition to those required by the federal programs. *Your employer is required to ensure that the training you have been provided meets those requirements.*

Your employer is responsible for getting you the proper training.



Lead can poison you and make you sick. Lead can poison children very quickly.

Work safely—protect yourself and others!

The more you know about lead, the better you can protect yourself and the more you can prevent lead poisoning.

Course introduction

Lead can be found in our air, water, soil, food, and many of our homes. Lead-based paint is a major source of exposure. In the United States, there are millions of structures that are painted with lead-based paint. The Centers for Disease Control and Prevention (CDC) estimate that over 400,000 children have lead in their blood above its level of concern.

Lead-based paint abatement is work that eliminates the lead hazards. EPA has defined what constitutes lead-paint, lead-dust, and lead-soil hazards. The work you will be doing in lead-based paint abatement is very important. If you work safely with lead, you can prevent lead poisoning.

However, if you do not work safely with lead, you can damage your health and your family's health. You can poison the environment. Children who move back into the homes you work on can become poisoned.

There are ways to protect yourself and to work with lead more safely. This is the reason you are here for this course. In this class you will learn:

1. What lead is and where you will find it.
2. How lead affects your health.
3. What laws and regulations are in effect that cover lead work.
4. How to work with lead dust safely.
5. Why good cleanup is important and how to do it.

When you follow the rules for working with lead, you lower your risk of getting poisoned. You protect your family and neighbors from lead poisoning. You protect the environment. When you work safely with lead, you help the national effort to end lead poisoning.



How to use this manual

This manual is yours to keep. Use a highlighter during the class and put notes on the sides of the pages to help you remember important information. This will help you when you study for the test at the end of the class. After the class is over, you can use this manual for information about your rights and responsibilities as a worker, the rights and responsibilities of your employer, and the legal requirements for safe work.

This manual is the 2001 version of the original EPA-model Lead Abatement Worker course manual that was originally published in May 1994 and revised in 1998. This manual has been updated to

- include changes to the Department of Housing and Urban Development's (HUD) *Guidelines for the Evaluation and Control of Lead-Based Paint Hazards in Housing*,
- incorporate EPA's definitions of paint-lead, soil-lead, and dust-lead hazards;
- address HUD's Lead-Safe Housing Rule which includes training requirements for maintenance, renovation and rehab workers; and
- include the work practice and clearance standards established by EPA.

The lead detection and control industry is still rapidly changing. There are key facts about working with lead that may be revised in the future. To keep up-to-date with information established after December 2001, do the following:

- Go to refresher training classes.
- Keep in contact with your training provider and others in the field.
- Talk with your local, state, and federal officials at least every 6 months.
- Read trade magazines.
- Use the resources listed in this manual.

Regulations or guidelines?

When you see these words in the manual, they indicate something that the laws and regulations say you **must** do: "have to," "must," "required," "shall."

When you see these words in the manual, they indicate something that is a good idea, but the law does **not** say you **have** to do it: "can," "may," "might," "suggested," "should."



Abbreviations and units of measure

Pages viii and ix contain lists which explain the abbreviations and units of measure used in the class. You may want to take these pages out of the manual so you can easily refer to them during the class.

Glossary and resources

There is a glossary and a resource section at the end of the manual to help you find information you may need. The glossary has definitions of important terms used in the manual. The resource section tells you where to get more information about lead—including how to get in touch with private groups and government agencies as well as how to order some of the publications mentioned in the manual.

There is a section called *For more information* at the end of each chapter that lists documents which can provide more information on the topic discussed in that section of the course. The documents with a star (*) should be available from your instructor for your review while in class.



Course Overview

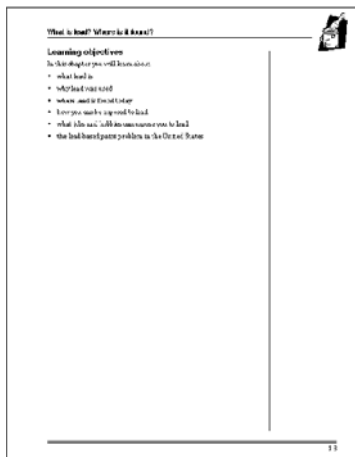

Learning objectives

Every chapter begins with an explanation of what you will learn in that chapter. For example, the learning objectives for Chapter 1 are on page 1–3.

LEARNING OBJECTIVES

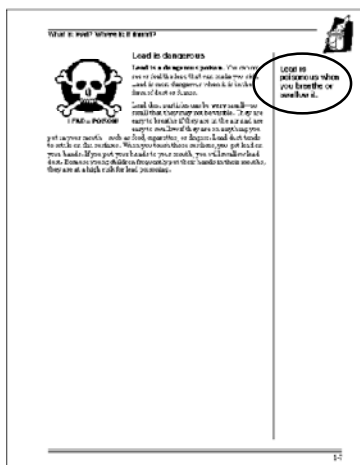

Pull quotes

The most important ideas in each chapter are printed in bold in the margins of the page. New words are often defined in the margins. Most of those terms are also in the glossary.

PULL QUOTES

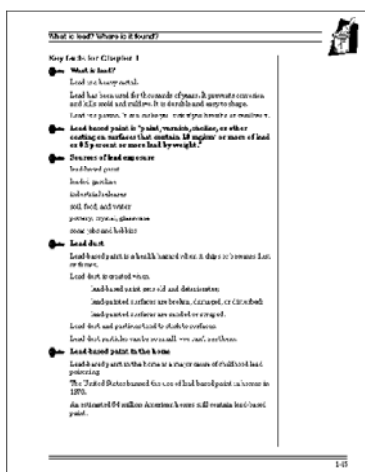

Key facts

Every chapter ends with a box called “Key Facts.” For example, the Key Facts for Chapter 1 are on page 1–15. This section reviews the most important ideas and words that are covered in the chapter.

KEY FACTS



Abbreviations

There are many abbreviations used throughout this manual. This reference guide will help you to remember what these abbreviations mean. All of the abbreviations and words on this page are defined in the glossary.

ASV	anodic stripping voltametry
CDC	Centers for Disease Control and Prevention
CFR	Code of Federal Regulations
COSH	Coalition (or Committee) on Occupational Health and Safety
EPA	Environmental Protection Agency
GFCI	ground fault circuit interrupter
HEPA	high efficiency particulate air
HUD	Department of Housing and Urban Development
HVAC	heating, ventilating, and air conditioning system
K-XRF	K-X-ray fluorescence
LBP	lead-based paint
MSDS	material safety data sheet
NIOSH	National Institute for Occupational Safety and Health
OSHA	Occupational Safety and Health Administration
PAPR	powered air-purifying respirator
Pb	The chemical symbol for lead
PEL	permissible exposure limit
PF	protection factor
Poly	polyethylene sheet plastic
RCRA	Resource Conservation and Recovery Act
TCLP	toxic characteristic leaching procedure
TSCA	Toxic Substances Control Act
TSP	trisodium phosphate
XRF	X-ray fluorescence
ZPP	zinc protoporphyrin



Units of measure

These units will be explained and defined during this course.

cm	centimeter
cm ²	square centimeter
dL	deciliter
ft	foot
ft ²	square foot
m	meter
m ³	cubic meter
g	gram
mg	milligram
µg	microgram
ppm	parts per million





CHAPTER 1

WHAT IS LEAD? WHERE IS IT FOUND?

Learning objectives	1-3
True / False quiz	1-4
What is lead?	1-5
Why was lead used?	1-6
Lead is dangerous	1-7
Lead causes health problems	1-8
Where is lead found?	1-9
Paint	1-9
House paint	1-9
Industrial use of lead-based paint	1-10
Leaded gasoline	1-10
Industrial releases	1-10
Sources of lead exposure.	1-11
Soil	1-12
Food	1-12
Drinking water	1-12
Hobbies	1-12
Occupational exposure	1-13
The lead-based paint problem in the United States.....	1-14
Key facts for Chapter 1	1-15
For more information	1-16





Learning objectives

In this chapter you will learn about

- what lead is
- why lead was used
- where lead is found today
- how you can be exposed to lead
- what jobs and hobbies can expose you to lead
- the lead-based paint problem in the United States



True / False quiz

This is an exercise to see how much you already know about lead. It is *not* a test. Please take a few minutes to read the statements, then circle T for “True” or F for “False.” Your instructor will go over the answers when everyone in the class is finished.

1. Lead is dangerous only to children under six. T F

2. We have known for thousands of years that lead is dangerous. T F

3. Experts can identify lead-based paint just by looking at it. T F

4. Lead exposure can affect a person’s ability to have children. T F

5. Lead is so dangerous that there is no way you can protect yourself from it. T F

6. The law says that if you find lead-based paint in a building, you must remove it as soon as possible. T F



Lead

What is lead?

Lead is a heavy, soft, flexible, blue-gray metal. It generally occurs in nature in the form of ores, and was recovered in early times as a by-product of smelting silver. Once lead is mined, processed and introduced into our environment, it can be a potential problem forever. Nearly all the lead to which we are exposed is due to people's activities.

The chemical symbol for lead is Pb. The symbol comes from the Latin word for lead—plumbum. The word plumber also comes from plumbum, because plumbers used large amounts of lead.

People used lead even before history was recorded. Egyptians used lead in solder, cosmetics, and building materials. Greeks and Romans used lead in plumbing. The first methods of transporting water into Rome were through aqueducts made from lead that carried water into the city from seven miles away. The Romans used lead to line food containers. They added lead to wine to sweeten it and to prevent spoiling.

**Lead is a heavy,
soft, flexible,
blue-gray metal.**



Lead has been used for thousands of years.

Why was lead used?

Lead was put in products for many reasons:

- **Prevents corrosion.** Lead will not crack easily with wear, weather, or temperature change.
- **Kills mold and mildew.** Lead is used in areas with high moisture.
- **Easy to shape.** Lead is a soft metal and melts at a low temperature (620° F).
- **Is strong.** Lead has a lot of mechanical strength.
- **Blocks radiation.** Lead is used in products designed to block radiation, such as the lead aprons used when X-rays are taken.
- **Blocks sound.** Lead was sometimes used for soundproofing.
- **Helps paint dry.** Lead was added to paint to quicken the drying process.
- **As a pigment.** Different compounds of lead were used to add color, to whiten, or to brighten paint.



LEAD = POISON!

Lead is dangerous

Lead is a dangerous poison. You cannot see or feel the lead that can make you sick. Lead is most dangerous when it is in the form of dust or fumes.

Lead dust particles can be **very small**—so small that they may not be visible. They are easy to swallow if they are on anything you put in your mouth—such as food, cigarettes, or fingers. Lead dust tends to settle on flat surfaces. When you touch those surfaces, you get lead on your hands. If you put your hands to your mouth, you will swallow lead

dust. Because young children frequently put their hands in their mouths, they are at a high risk for lead poisoning. You can also breathe in lead dust.

Lead is poisonous when you swallow it or breathe it.



**Lead poisoning
was recognized
2,000 years ago.**

Lead causes health problems

The health problems associated with lead have been known for a very long time. Ancient Egyptians knew that lead could kill people if they swallowed too much of it. In the Middle Ages, doctors realized that some of the health problems of painters, miners, and artists were caused by exposure to lead on the job. In 1786, Ben Franklin wrote to a friend about work-related lead poisoning cases.

In the early 1900s, doctors found that lead-based paint caused reproductive problems for workers and their families. Doctors from all over the world began to study lead-based paint as a cause of childhood diseases. Many doctors in the United States studied and wrote articles about childhood lead poisoning. In 1913, Dr. Alice Hamilton—an American occupational health doctor—wrote about painters and the hazards of their work. She documented their exposure to lead and their health problems.



Where is lead found?

Lead can be found almost anywhere today. Some of the places where we may find lead include the following:

Paint



“Lead-based paint” is defined in the Residential Lead-Based Paint Hazard Reduction Act (also known as Title X) as “paint, varnish, shellac, or other coating on surfaces that contain 1.0 mg/cm² or more of lead or 0.5 percent or more lead by weight.” Chapter 3 will cover ways to identify lead-based paint.

Lead was used in paints for color and durability. When lead was added to paint, the paint was better able to stand up to wear and tear and weather changes. Lead was also added to paints to speed up the drying process.

In many ways, lead-based paint was an ideal product. However, as lead-based paint ages or becomes damaged, dust and chips are created.

Lead dust pollutes the air, soil, household dust, and any surface it settles on. It contaminates floors, counter tops, furniture, toys, shelves, books, pets, and people. It can get on children’s hands when they play on the floor. When lead-based paint gets old or damaged, it creates lead dust and chips. Lead dust can be a health hazard. Many lead-poisoned children are exposed to and poisoned by lead dust. Even when the floor looks clean, there may be harmful amounts of lead dust. Lead dust and lead-contaminated soil can be tracked indoors (e.g., by pets or on shoes) where it becomes another source of exposure for children. It is normal for children to put their hands and toys in their mouths and then swallow lead dust. The action called “hand-to-mouth contact” is the most common way for children to ingest lead.

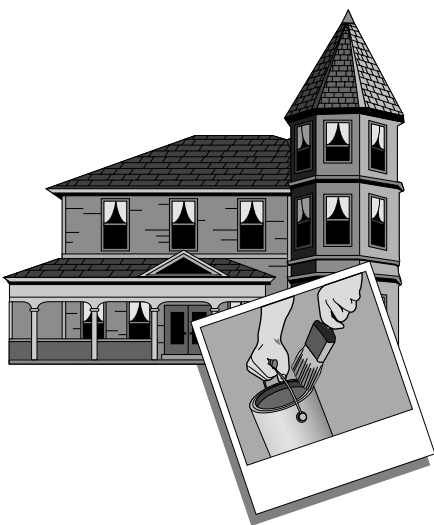

House paint

Lead-based paint is believed to be a major source of lead poisoning. Any home built before 1978 may contain lead-based paint. Homes built before 1950 are more likely to contain higher levels of lead because the use of latex paints became more common during the 1950s.

When lead-based paint gets old or damaged, it creates lead dust and chips.

Lead dust is a health hazard.

Most children are exposed to lead by ingesting lead dust.

Lead-based paint can be found on any painted surface—inside or outside.



Sand blasting paint off a bridge can pollute the community.

Lead-based paint was used inside homes on woodwork, walls, floors, windows, doors, and stairs because it resisted wear and tear. It was also used on the outside of homes, porches, windows, and doors because it can withstand extreme weather changes.

Lead-based paint kills mold and mildew. Because mold and mildew typically grow in high moisture areas, lead-based paint was often used in places where moisture is found (such as kitchen and bathroom walls and on windows and doors).

Industrial use of lead-based paint

Lead-based paint is still used on bridges and on steel structures to prevent rust and corrosion. These are “industrial uses” of lead-based paint. There are no restrictions on the use of lead-based paint for industrial purposes.

About 90,000 bridges in the United States are coated with lead-based paint. Blasting or grinding lead-based paint off steel structures and even performing routine repairs creates huge amounts of lead dust. Doing this type of work can be harmful to workers and the surrounding community. The lead dust gets into the air and nearby soil, plants, and water.



Exhaust from leaded gas polluted the air and soil.

Leaded gasoline

Until the late 1970s, lead was added to gasoline as an antiknock agent. The car exhaust released the lead into the air and because lead is heavy, this lead polluted not only the air but also the soil.

In 1978, the Environmental Protection Agency reduced the amount of lead that could be added to gasoline. By 1982, the U.S. national average level of lead found in the typical person’s blood dropped by 37 percent. Today the amount of lead permitted in automobile gasoline is limited to 0.05 grams per gallon of gasoline. A higher amount of lead is still allowed for farm vehicles and equipment. Leaded gas is still used in other countries including Mexico, Korea, and Ireland.



Industrial releases

Many industries use lead in their products. For example, lead is used in batteries, ceramics, lead crystal, and bullets. When these items are produced, lead can be released into the air. The production and use of these materials can pollute soil, water, and air.

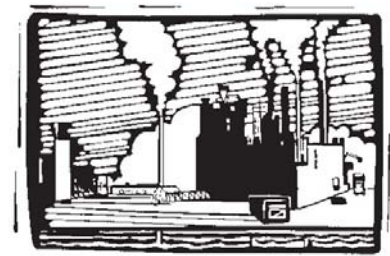



SOURCES OF LEAD EXPOSURE

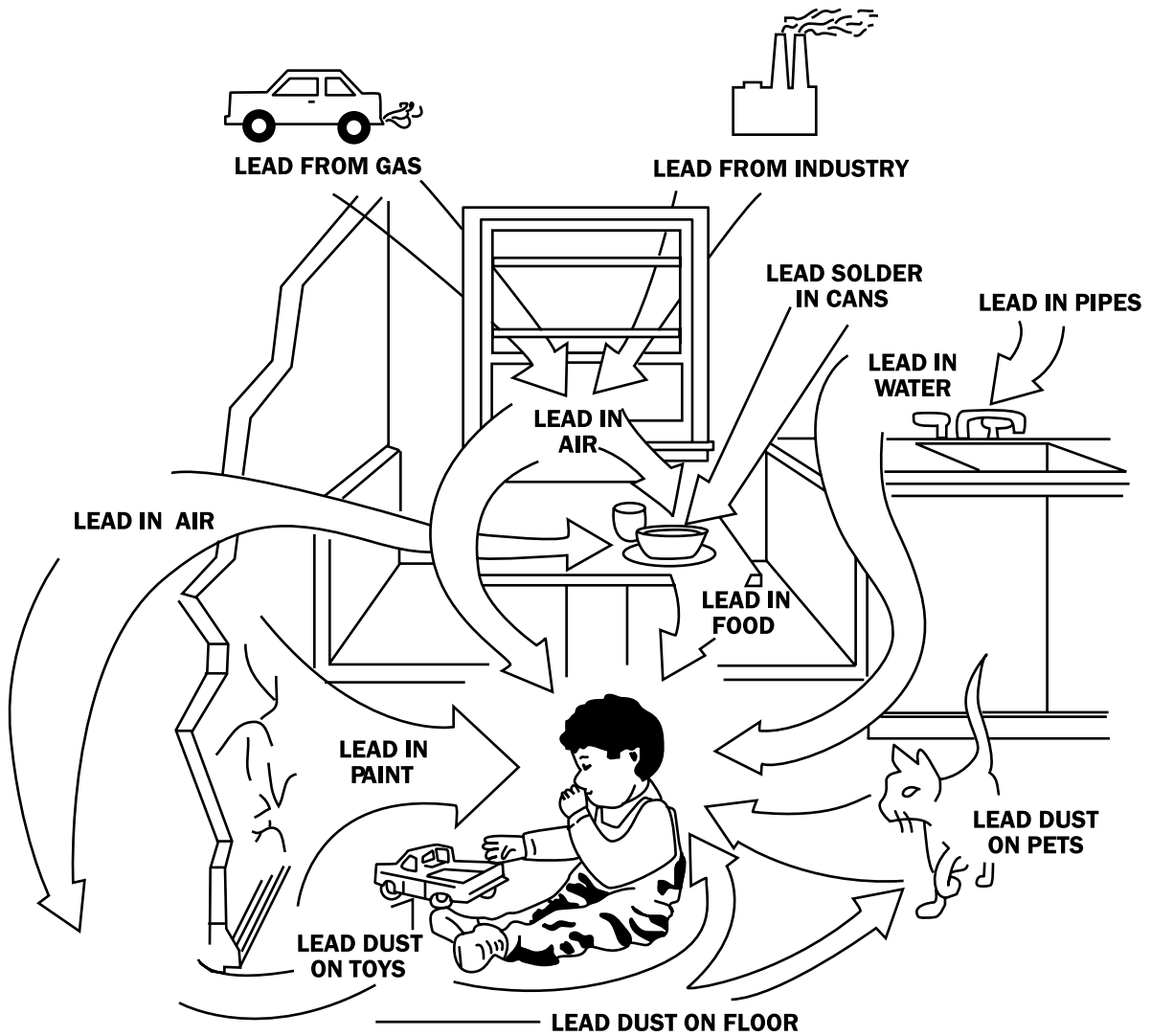

Adapted from "Preventing Lead Poisoning in Young Children," Centers for Disease Control January 1985



Soil can have high levels of lead.

Soil

High levels of lead in soil may come from paint dust, leaded gas exhaust, and industrial releases. Naturally-occurring traces of lead are found in most soil.

Some playgrounds may have soil that contains very high levels of lead. Such playgrounds are very dangerous to children who play there because of the risk of ingesting the lead during normal hand-to-mouth contact.

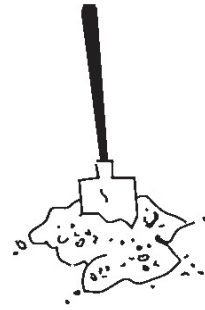

Food and drinking water can be sources of lead.

Food

Food grown in soil that has lead can also contain lead. Ceramic ware, pottery and glassware may contain lead which can leach into foods cooked in or eaten from these items.



Lead-soldered cans are no longer produced in the United States, but lead-soldered cans are permitted in some countries that export food to the United States.

Food cans imported from other countries may contain lead in the solder holding the cans together. Any can containing lead must have a label on the can which states the amount of lead used in the solder.

Drinking water

Lead was used in pipes and solder—even in water coolers! Because lead can easily expand without cracking, it was ideal for use in plumbing systems where freezing is possible. The Safe Drinking Water Act (1986 and 1988) made it illegal to use lead in household plumbing. However, old lead pipes and lead soldering can still contaminate drinking water. Lead is rarely a naturally occurring contaminant in water.

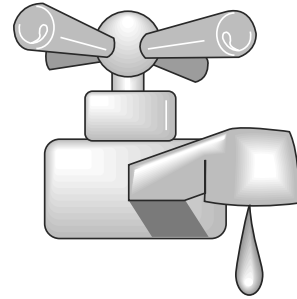

Hobbies

Many people can be exposed to lead in their hobbies. Activities that may expose you to lead are

- home remodeling
- glazed pottery making
- target shooting at firing ranges
- electronics
- car and boat repair

Some hobbies can expose you to lead.

What is lead? Where is it found?



- refinishing furniture
- painting—some art paints have lead pigments
- making lead fishing sinkers or lures
- stained-glass window making

Occupational exposure

Many jobs or occupations can expose people to lead. These workers are in danger of lead poisoning and may also contaminate their cars and homes by bringing lead dust home on their clothes, shoes, hair, or skin.

If workers don't clean up properly before leaving a worksite, they could poison their own families.

Some jobs that have a high risk of lead exposure include



Many workers are exposed to lead on the job.

Construction trades

- Lead abatement workers
- Carpenters
- Remodelers
- Renovators
- Demolition workers
- Ironworkers
- Steel welders and cutters
- Sheet metal workers
- Painters
- Plumbers and pipe fitters

Industry

- Lead miners
- Lead smelter workers
- Lead refinery workers
- Lead crystal makers
- Ceramic glaze manufacturers
- Plastic manufacturers
- Wire and cable manufacturers
- Electronics makers

Others

- Firing range employees
- Police officers
- Artists
- Radiator repair workers
- Car mechanics
- Printers
- Scrap yard workers and recyclers



In 1978, the U.S. banned the use of lead-based paint in homes.

Millions of homes in the U.S. have lead-based paint.

The lead-based paint problem in the United States

Lead is a known poison. Other countries limited the use of lead-based paint as early as 1840. The United States did not act until the 1970s. The U.S. Government banned the use of lead-based paint in houses, hospitals, schools, parks, playgrounds, and public buildings in 1978. Although the government banned the use of lead-based paint in 1978, it allowed stores to sell-out their existing stock until 1980. Typically, we do not expect to find lead-based paint in houses built after 1980.

Lead-based paint can still be used on cars, boats, metal furniture, industrial steel, farm equipment, and on roads as traffic paint.

Today about 38 million U.S. homes contain lead-based paint. This number includes houses and apartments in the cities, in suburbs, and in the country. It includes the homes of wealthy people as well as the homes of middle-class and lower-income people. Homes built prior to the 1950s are more likely to contain lead-based paint. After the 1950s, latex paints became more popular, and many people chose them instead of lead-based paints.

There have been some reports of childhood lead poisoning that occurred during or after renovation in homes with lead-based paint. Many homes with lead-based paint are occupied by families with children under age six. Children under six are easily hurt by lead because their nervous systems are still developing. How children get poisoned by lead and what lead does to their bodies is discussed in the next chapter.



87 percent of homes built before 1940 have lead-based paint.

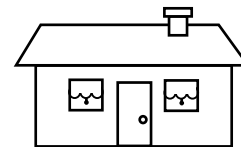

24 percent of homes built between 1960 and 1979 have lead-based paint.

Adapted from

U.S. HUD. 2001. The National Survey of Lead and Allergens in Housing.



Key facts for Chapter 1

What is lead?

Lead is a heavy metal.

Lead has been used for thousands of years. It prevents corrosion and kills mold and mildew. It is durable and easy to shape.

Lead is a poison. It can make you sick if you breathe or swallow it.

Lead-based paint is “paint, varnish, shellac, or other coating on surfaces that contain 1.0 mg/cm² or more of lead or 0.5 percent or more lead by weight.”

Sources of lead exposure

lead-based paint

leaded gasoline

industrial releases

soil, food, and water

pottery, crystal, glassware

some jobs and hobbies

Lead dust

Lead-based paint is a health hazard when it chips or becomes dust or fumes.

Lead dust is created when

lead-based paint gets old and deteriorates;

lead-painted surfaces are broken, damaged, or disturbed;

lead-painted surfaces are sanded or scraped;

household dust becomes contaminated by other sources of lead (e.g., soil).

Lead dust and particles tend to stick to surfaces.

Lead dust particles can be so small, you can't see them.

Lead-based paint in the home

Lead-based paint in the home is a major cause of childhood lead poisoning.

The United States banned the use of lead-based paint in homes in 1978.

An estimated 38 million American homes still contain lead-based paint.



For more information

These publications have more information on the topics covered in this chapter. Your instructor has a copy of the publications marked with a star (*). You can order your own copy by calling 1-800-424-LEAD.

* Environmental Defense Fund, *The Hour of Lead: A Brief History of Lead Poisoning in the United States over the Past Century and of Efforts by the Lead Industry to Delay Regulation* (June 1992).

* EPA, *Lead: Identification of Dangerous Levels of Lead; Final Rule*, 40 CFR Part 745 (January 2001)

* EPA, *Reducing Lead Hazards When Remodeling Your Home* (September 1997).

* EPA, *Lead in Your Drinking Water* (April 1993).

* EPA, *Home Water Treatment Units: Filtering Fact from Fiction* (September 1990).

* EPA, *Toxics Information Series on Lead* (Pamphlet TS-793).

* EPA, HUD, and CPSC, *Protect Your Family From Lead in Your Home* (June 2003).

National Lead Information Center, *Lead: Some Questions and Answers* (April 1993).

National Lead Information Center Hotline: 1-800-424-LEAD



CHAPTER 2

HEALTH EFFECTS: HOW LEAD AFFECTS THE BODY

Learning objectives	2-3
Skit: Lunchtime on the job site	2-4
Discussion questions	2-5
Lead poisoning affects you	2-6
How much lead is dangerous?	2-7
How does lead get into your body?	2-8
How can lead harm your body?	2-9
Children are at high risk	2-13
Protect yourself and your family from lead poisoning!	2-14
Health effects of lead poisoning	2-15
Short-term or long-term effects	2-16
Reversible or permanent damage	2-16
Testing for lead in your body	2-17
Blood lead level test	2-17
ZPP test (Zinc Protoporphyrin)	2-17
Blood lead levels	2-18
Preventing lead poisoning	2-20
Making sure that you do not get sick	2-20
Good nutrition	2-21
Key facts for Chapter 2	2-22
For more information	2-24





Learning objectives

In this chapter you will learn

- how lead enters and affects the body
- why lead is especially dangerous to children
- how lead levels in the body are measured
- how lead poisoning can be prevented



Skit: Lunchtime on the job site

Tanja, Al, Joe, and Walt are eating lunch on the back porch of a home they are renovating. They live in the community where the home is located. They have been renovating the houses in this community for nearly a month. Let's listen to them while they eat lunch:

Al: This porch is feeling like home. We've worked on these houses for a month now. We'll be done by next week.

Tanja: It'd feel more like home if we had a table and a few chairs to sit on. I'll be glad when this job is over. I'm tired. My body aches from all this work.

Joe: Women weren't made to work construction—that's why your body aches. I don't want a table or chairs. I want a clean bathroom and some cold water to drink. This porch is dirty. Maybe we could get some of that poly plastic and lay it on the porch . . . man, I'm dizzy.

Al: Tanja, I've seen you do twice as much work as Joe in a day. Are you sick?

Walt: Hey, Joe, too much partying last night? We've worked on these houses for almost a month. I won't miss this porch at all. I used to get real hungry by lunch time. I was eating two or three sandwiches. I'm working just as hard now, but I don't even want to finish one sandwich anymore.

Al: Walt, you usually eat like a horse. Ask your wife to fix your lunches again.

Walt: My wife made my favorite pot roast last night. I couldn't eat it. It tasted so good, but I wasn't hungry. My stomach hurt. All I wanted to do was go to sleep.

Joe: I wish I could get some sleep. The past week I got these headaches and people just bothered me. You know, people are getting on my nerves. The doctor says it's because I'm constipated.

Al: You all sound like you got the flu or some kind of bug. Stay away from me. I'm feeling just fine and I want to stay that way.

**Discussion questions**

1. What is going on in this conversation?
2. What were the workers' complaints?
Circle them in the script. Is everyone feeling sick?
3. Do any of the workers share the same problems?
4. List some things that could be causing these complaints.
5. What suggestions were made to fix the problems?

What would you suggest?

What do you think?





Lead poisoning affects you

Lead is poisoning many children and adults around the country. As a lead abatement worker, you can also be poisoned by lead. It can make you very sick and can even kill you. At low levels of exposure, you can feel fine, but lead is still harming you. When you work with lead, you must work carefully. Lead poisoning can be prevented by working with lead-based paint safely. You are in this class to learn how to protect yourself, others, and the environment from lead.

As a construction worker—especially if you do remodeling, demolition, or lead-based paint abatement work—you may be exposed to lead. Without proper protection, **you can get sick from lead in the workplace.** You should wear a respirator and protective clothing when you work with lead. Clean up, shower, and put on clean street clothes before going home. If you forget to shower before leaving the job site or you wear dirty work clothes home, you could expose your family to lead.



How much lead is dangerous?

Even a small amount of lead can make you sick. Lead can remain in the body for a long time. It stays in the blood for several months and can be stored in the bones for 30 years or more.

The more lead you are exposed to, the more likely you are to get lead poisoned. Many small doses of lead over a long time can cause lead poisoning. One large dose of lead in less than a day can also make you lead poisoned. A low dose of lead can make you feel tired and irritable. A high dose of lead can cause permanent damage to your brain, nervous system, and kidneys. A very high dose of lead can cause death.

Even a small amount of lead can harm you.



How does lead get into your body?

Lead can get into our bodies in two ways: breathing (or inhalation) and eating (or ingestion).

Breathing lead

When lead is in the air, you can breathe tiny lead particles into your lungs. Once in your lungs, lead is absorbed into your blood stream.



Eating lead

You can swallow lead particles by eating, drinking, smoking, or chewing your fingernails without washing your hands after working with lead. If you swallow lead particles, the lead eventually goes through your digestive system and then slowly gets into your blood.

Up to 50 percent of the lead that children and pregnant women ingest is absorbed into their bodies. About 10 to 15 percent of the lead that nonpregnant adults ingest is absorbed into their bodies. People who do not get enough calcium or iron in their diets will absorb more lead into their bodies.



You can breathe or swallow lead.

You may swallow lead if you don't wash before you eat or smoke.



How can lead harm your body?

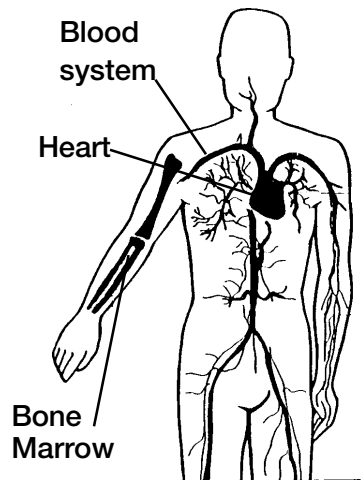

Heart and blood system

When lead reaches your blood, it attaches to red blood cells in the area where iron and oxygen are. If your body does not get enough iron, lead will attach to the red blood cells more quickly. Then, the red blood cells cannot carry oxygen, and you cannot get oxygen to the rest of your body. Without enough iron or red blood cells in the blood, a condition called **anemia** can develop. Anemia can make you very tired.

Lead can damage red blood cells by shortening the life of the cells. Lead also reduces your body's ability to make more red blood cells in the bone marrow.

Lead poisoning may cause high blood pressure.

When you have high blood pressure your heart muscles cannot relax. This increases your risk of heart attack and stroke.

Lead attaches to your red blood cells.

Lead can cause high blood pressure.

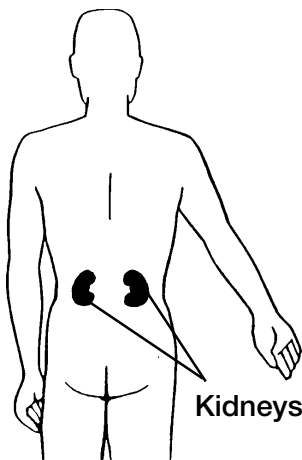

Kidneys

Your blood is cleaned and filtered in your kidneys. Most (65 percent) of the lead that is in the blood gets filtered in the kidneys, where it can cause damage. Kidney damage can be very serious. Often this damage cannot be detected until much of the kidneys' function is lost. This damage requires serious medical treatment to prevent the kidneys from failing. Kidney failure can cause death.

Nervous system

The nervous system is the system in your body most affected by lead. The nervous system includes your

rain, spinal cord, and nerves. The damage lead causes to the nervous system can be permanent.

Lead damages the brain and can even kill brain cells. Lead damage to your brain can make you depressed, irritable, forgetful, clumsy, and affect your ability to learn. At very high doses, lead poisoning can cause hallucinations, swelling of the brain, coma, and even death.

Lead damages the ability of your nerves to give and receive messages. Lead can damage the nerves that go to your hands and feet. This nerve damage can cause your hands to shake; and in severe cases, it can cause your hand or foot to become weak and drop. If wrist drop or foot drop develops, you may never have full use of your hand or foot again.

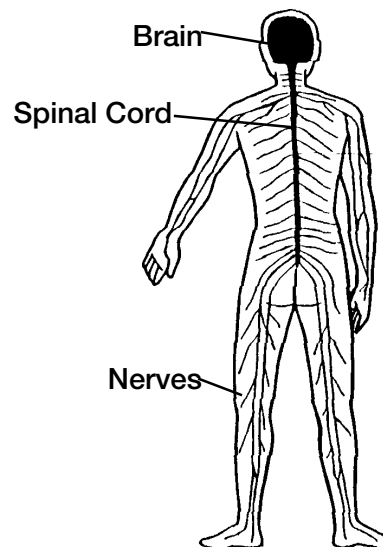

Lead can damage your kidneys.

Lead can damage your brain and nerves.



The nervous system of a fetus, infant, or child is affected by even small amounts of lead. Lead poisoning can decrease the intelligence of children. Lead can cause behavior problems in children. Some studies have linked learning disabilities, such as attention deficit disorder (ADD), and delinquent behavior to childhood lead poisoning.

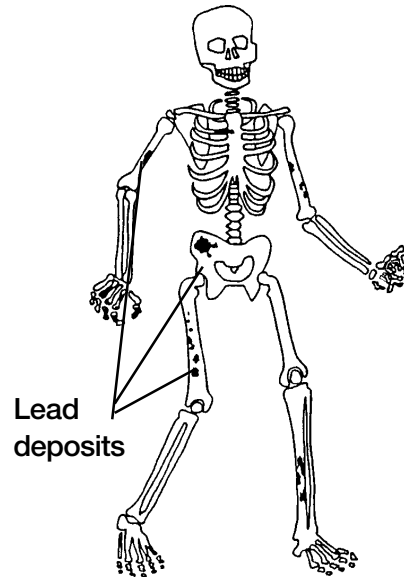

Bone tissue

As blood travels through the bones, lead from the blood is deposited into the bone tissue. Lead blocks your body's natural process of making new blood cells.

Lead also competes with calcium in the bone. Calcium is released from bone tissue as our bodies need it. If lead is there instead of calcium, then lead is released into the blood.

The bones and teeth store 95 percent of the lead in the body. **Lead can be stored in bone tissue for more than 30 years.** Lead can be cycled from bone to blood to body organs. When the body is under stress, lead is released from the bone tissue into the blood. A body is under stress during illness, overactivity,

pregnancy, or during times of anxiety. **If the lead goes from the bone back into the blood, then other body systems are exposed, and problems can begin all over again.**

Lead that stays in your body is called a “**body burden.**” The more lead you are exposed to, the higher your lead body burden is. The lead body burden is not easy to measure because it is mostly found in your bone tissue. Samples of bone tissue are difficult to get. A child's tooth can be tested for lead when it falls out. The tested tooth can tell you how much lead is in the child's bones—that is, the child's lead body burden. A special X-ray machine can measure shin bone lead to tell us body burden, but these machines are used for research only.



Health Effects: How Lead Affects the Body

Female reproductive health and Pregnancy

Lead poisoning is very dangerous to the female reproductive system. It can make women less fertile and can cause abnormal menstrual cycles and affect menopause.

During pregnancy, current or past exposure to lead by the mother could present a risk to the fetus. When a woman is pregnant, the fetus gets blood from the mother. If the mother has been exposed to lead, the lead absorbed by her body could be released and passed on to the fetus through the blood. This lead could cause brain damage and even death to the fetus. It could also cause miscarriages and premature (early) births.

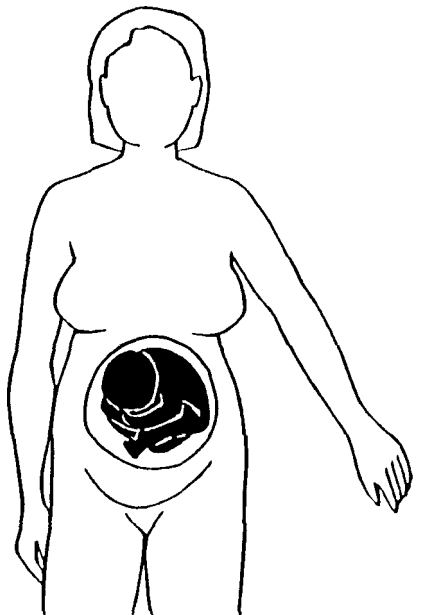

Even a small amount of lead can make a pregnant woman sick.

Lead can cause miscarriages and birth defects.

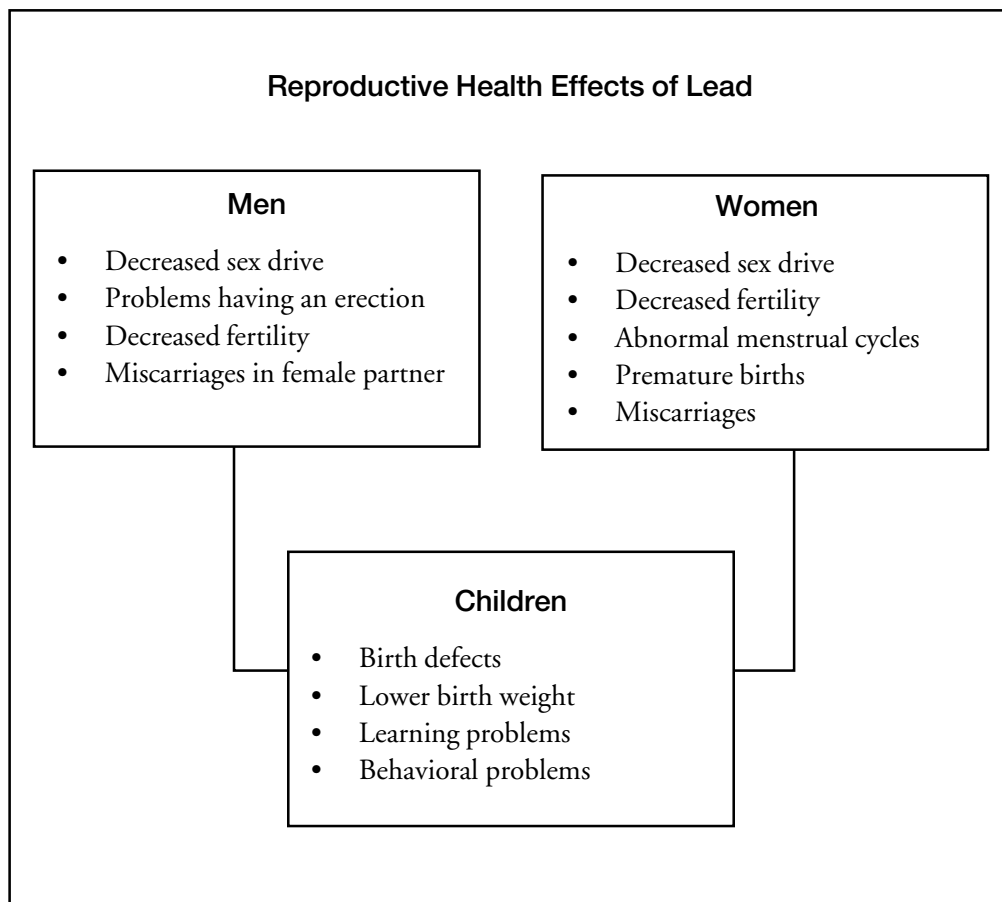



Lead can cause men to have difficulty having an erection.

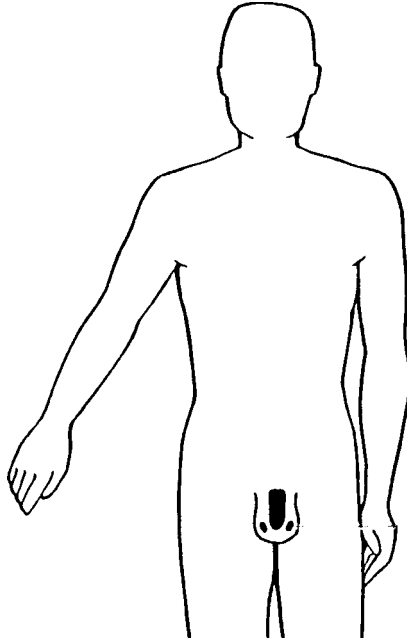

Male reproductive system

Lead is very dangerous to the male reproductive system. Lead can make men lose interest in sex, and it can cause men to have problems having an erection. Lead can cause infertility. It damages sperm. Lead causes the sperm to have an odd shape. It makes sperm move slowly. Wives of leadpoisoned workers have more miscarriages and premature births, and their children have more birth defects.

Fetal protection policies

In the past, many companies developed policies with the stated purpose of protecting the fetus. They were called **fetal protection policies**. Fetal protection policies may really have been developed to protect the companies against lawsuits.

To keep their jobs, women were forced to prove they could not have children. Women who wanted to have children in their lifetime were fired or given lower paying jobs. In some cases, women had to be sterilized to keep their jobs.

In 1991, the Supreme Court decided that fetal protection policies discriminated against women. Fetal protection policies are now illegal.

Lead affects both male and female reproductive systems. Both men and women need to be protected from harmful levels of lead to have healthy babies. The employer must provide a safe workplace for both male and female workers.



Children are at high risk

Children can get lead poisoned very quickly. Even a small dose of lead can poison a young child. A child's rapidly developing brain, central nervous system, and entire body are affected by lead. Toddlers (age one to three) are at a very high risk of lead poisoning, because they typically crawl on floors and put things in their mouths and therefore can swallow a lot of lead dust. Children absorb up to 50 percent of the lead that they take in.

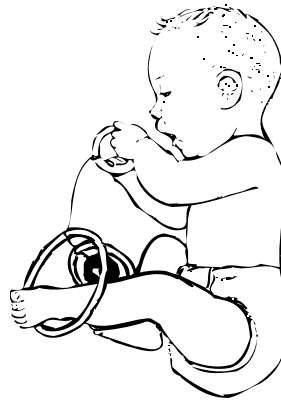

Recent medical research indicates that lead may affect a child's intelligence even at blood lead levels below 10 micrograms per deciliter ($\mu\text{g}/\text{dL}$). Lead-poisoned children have a higher high school dropout rate than non-lead-poisoned children. Lead poisoning can reduce a child's ability to learn. It can also cause

- poor muscle and bone growth
- poor hearing
- speech and language problems
- coordination problems

Lead is the most significant environmental health hazard for children in the United States. Some research has suggested that children exposed to lead may be hyperactive. Other studies have found evidence that lead can make a child react very slowly. Still other research studies indicate that lead can make it hard for a child to pay attention (Attention Deficit Disorder). Lead can make a child very clumsy. Lead kills brain cells and disrupts nerve signals. The effects of childhood lead poisoning can last a lifetime.

Even low levels of lead can cause permanent damage to a child.

Children's developing bodies and brains are easily damaged by lead.

Lead is the most significant environmental health hazard for children in the U.S.

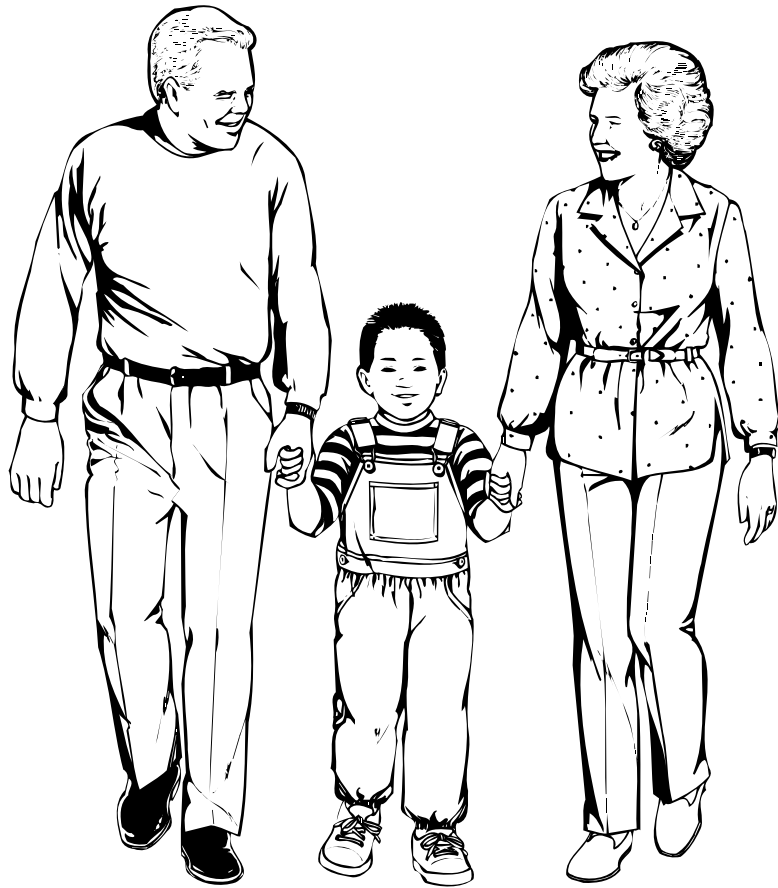

Protect yourself and your family from lead poisoning!

Julia's husband Mike is an auto mechanic and machinist. He is exposed to lead on the job. Julia was exposed to lead on the job for three months while she worked in a shipyard as a burner. Two years later, Julia became pregnant with their son. The parents' lead exposure may have affected their son's health.

"As my son grew up," says Julia, "he developed learning disabilities. He had a lot of trouble paying attention and following directions. He has really poor organization skills. We had to send him to a special education program for several years. My son is 14 years old now. He's doing better, but he still needs help organizing. He still needs special care."

From interview with a worker. (The names have been changed.)



Health effects of lead poisoning

Lead poisoning can affect you in many different ways. A large amount of lead can make you sick right away. A small amount of lead day after day can make you sick over a long period of time.

The health effects of lead poisoning are often difficult to recognize. There are many different signs and symptoms of lead poisoning that can also be caused by a number of other things, like the flu or a cold. Because the symptoms are so similar, lead poisoning can easily be mistaken for a cold or the flu.

Sometimes the signs of lead poisoning come and go. You have them one day and then they disappear. Then the signs come back again. This can happen for several months.

Lead can cause damage without symptoms. Lead poisoning often goes unnoticed, and you may not know you have lead poisoning. Children with lead poisoning may seem healthy while damage is being done to their bodies. Signs and symptoms of the damage usually do not develop until the condition is serious.

Signs and symptoms of lead poisoning

- Tiredness (fatigue)
- Sleep problems
- Dizziness
- Irritability
- Nervousness
- Headaches
- Difficulty concentrating
- Depression
- Forgetfulness
- Hyperactivity (children)
- Numbness
- Wrist or foot drop
- Weakness
- Clumsiness
- Joint and muscle pain
- Vomiting
- Loss of appetite
- Stomach aches
- Constipation
- Metal taste in the mouth
- Problems having healthy children

Some health effects of lead poisoning

- Anemia
- High blood pressure
- Damage to blood cell formation
- Kidney disease
- Brain damage
- Nerve damage
- Decreased fertility
- Premature births
- Miscarriages

You may not know that you have lead poisoning.

Lead can cause damage without signs or symptoms.

Lead poisoning is sometimes mistaken for the flu.

The health effects of lead poisoning are often difficult to recognize.



Lead can cause permanent damage.

Short-term or long-term effects

Sometimes the effects of lead poisoning are **short term**. This means they do not last a long time—maybe a few weeks or months. Sometimes the symptoms of lead poisoning are **long term**. This means the symptoms stay with you a long time—sometimes for years or even permanently. Long-term effects can be caused by repeated small doses of lead or by a very high dose at one time.

Reversible or permanent damage

Some effects of lead poisoning can be **reversed**. This means the effects may go away. High blood pressure is an effect of lead poisoning that is reversible. High blood pressure can return to normal when the lead in your body decreases.

Lead poisoning can cause **permanent damage**. This means that the damage is always there. An example of permanent damage caused by lead is wrist drop. Wrist drop is when your wrist hangs limp at the end of your arm. You may never be able to use that hand again. Wrist drop is caused when lead damages your nervous system. When lead damages the development of the electrical connections in a child's brain, the effect is permanent.

Lead can cause permanent damage to your

- brain
- learning ability
- coordination
- hearing
- nerves
- digestive system
- heart
- blood cell formation
- kidneys
- reproductive system



Testing for lead in your body

The only way to determine the amount of lead in your body is to get a blood test. When lead enters your body, it gets into your blood. The amount of lead in your blood is called your **blood lead level**.

There are two kinds of tests to monitor blood lead levels—the blood lead level test and the ZPP test (zinc protoporphyrin). Both tests can be done from blood taken from either your arm or your finger. Both can be done from the same sample of blood.

Blood lead level test

This test measures the amount of lead in your blood. Blood lead levels are only a snapshot of lead exposure. The test shows how much lead you have been exposed to in the **last 6 to 8 weeks**. The blood lead test is the more accurate test. Your blood lead level is measured in **micrograms** of lead per **deciliter** of blood ($\mu\text{g}/\text{dL}$).

ZPP test (Zinc Protoporphyrin)

ZPP is produced when lead stops one of the body's building blocks from making blood. Your ZPP level becomes abnormal when a lot of lead has entered your body over the last **few months**. It tells how much lead your body has absorbed by looking at some of your body's building blocks. It does not measure the amount of lead in your blood. Results are measured in **micrograms per deciliter** ($\mu\text{g}/\text{dL}$). Normal results for the ZPP test are 35-50 $\mu\text{g}/\text{dl}$. The ZPP test is not as accurate as the blood lead level test for early or low-level lead exposures. ZPP results can vary because of diet, anemia, and other factors.

Blood tests find out how much lead is in your blood.

Understanding Units

A **microgram** is a measure of weight. There are 1 million micrograms in a gram. The abbreviation for microgram is μg .



A penny weighs about two grams. Imagine cutting a penny into 2 million pieces. A microgram would weigh the same as **one** of those 2 million pieces.

A **deciliter** is a measure of volume. It is equal to a little less than half a cup. A person weighing 165 pounds has about 60 deciliters of blood. The abbreviation for deciliter is **dL**.





You may not know that lead is harming you.

People have different reactions to the same blood lead level.

Blood lead levels

Recent studies claim that lead can be harmful at blood levels below 10 µg/dL. Imagine that penny broken up into 2 million pieces again. Now picture 10 of those pieces dissolved in a half cup of liquid. That tiny amount of lead in your blood can cause health problems!

Lead is dangerous because it builds up in your body. It can stay there for years. It is difficult to say exactly what happens to your body with specific lead levels because each person is different. Different people have different reactions to lead in their bodies. You may not know that lead is harming your body. Some people do not even know that they are having problems with lead poisoning when their blood levels are 60 µg/dL. Other people suffer obvious signs of lead poisoning at 30 µg/dL.

ADULT REACTIONS TO LEAD

Blood Lead Level	Possible Health Effects
15 µg/dL	Increase in blood pressure; harmful effects on fetus; joint and muscle aches
25 µg/dL	Reproductive problems
40 µg/dL	Kidney damage; damage to blood formation
60 µg/dL	Anemia; nerve damage; constipation; stomach pains; irritability and fatigue; memory and concentration problems; clumsiness; drowsiness and sleep problems
80 µg/dL and above	Blue line on gums; uncontrollable shaking of hands; wrist and foot drop; hallucinations; brain damage; coma; death

ATSDR 1989; California Health Department 1993



Every child is also different in his or her reaction to lead. A lead poisoned child may not look or act sick but his or her body is being damaged. Researchers have known for a long time that children are especially sensitive to lead exposures. Scientists have discovered that even very low exposures to lead can cause serious health effects in children.

In 1991, the Centers for Disease Control and Prevention (CDC) lowered the level of concern for children's blood lead levels from 25 µg/dL to 10 µg/dL. About 2 percent of all children aged 1 to 5 years (about 400,000 children) are estimated to have blood lead levels at or above 10 µg/dL. Lead dust from deteriorating lead-based paint is the major source of lead exposure for children.

The effects of lead can be different for each child.

CHILD REACTIONS TO LEAD	
Blood Lead Level	Possible Health Effects
10 µg/dL	Slight loss in IQ; hearing and growth problems
20 µg/dL	Moderate loss in IQ; hyperactivity; poor attention span; difficulty learning; language and speech problems; slower reflexes
40 µg/dL	Poor bone and muscle development; clumsiness; lack of coordination; early anemia; fewer red blood cells to carry oxygen and iron; tiredness; drowsiness
50 µg/dL	Stomach aches and cramps; anemia; destruction of red blood cells; brain damage
100 µg/dL and above	Swelling of the brain; seizures; coma; death

A child who has lead poisoning may not look or act sick.



Lead poisoning can be prevented.

Preventing lead poisoning

One way of reducing the chance of lead poisoning is to properly abate lead-based paint hazards in homes that are occupied by children. Lead-based paint **abatement** eliminates the lead hazard permanently. Abatement can be expensive and often cannot happen right away. In that case **interim controls** may be used to control the lead hazard. “Interim” means temporary. Interim controls reduce the amount of lead that children are exposed to without permanently removing the source. Depending on the extent of the lead hazard, interim controls may not take the place of abatement. **By doing lead abatement and using interim controls, you are helping prevent lead poisoning.** (Chapter 6 will cover abatement and interim controls.)

Making sure that you do not get sick

When you work with lead, you have a higher risk of getting lead poisoned. As much as possible should be done to reduce that risk. Some things that you can do are

- make sure your employer provides a safe workplace;
- know your rights as a worker;
- wear protective gear;
- use safe work practices;
- make sure you don't create a lead hazard while you work;
- use good personal hygiene;
- do not take lead home on your clothes or in your car;
- get the medical exams that your employer provides;
- inform your employer if you develop any signs of lead poisoning;
- avoid lead-related work if your blood lead level is too high;
- eat a balanced diet.



Health Effects: How Lead Affects the Body

Good nutrition

Good nutrition is important for anyone exposed to lead. A diet with enough iron and calcium prevents worse lead poisoning. When you eat a diet high in iron and calcium you can reduce lead absorption. People with low amounts of iron and calcium absorb more lead than those with normal amounts of iron and calcium. If you have enough iron and calcium in your body, lead will be absorbed less quickly. Research shows that vitamin C, zinc, and protein—found in a well-balanced diet—appear to decrease lead absorption. Foods with a lot of fat, such as fried foods, appear to increase lead absorption. When choosing dairy products, try to eat low-, non-, or reduced-fat varieties.

Eat foods high in iron—cheese, fish, seafood, meat (especially liver), eggs, spinach, beans, raisins, apricots, seeds (pumpkin, squash, sunflower), black walnuts, almonds, barley, wheat germ.

Eat foods high in calcium—milk, cheese, ice cream, yogurt, bread, fish, seafood, meat, beans, broccoli, leafy green vegetables (spinach, etc.), cherries, blackberries, raisins, fruit juice (orange, prune, grapefruit, pineapple), peaches, apricots, dates, sunflower seeds, almonds, hazelnuts, pecans.

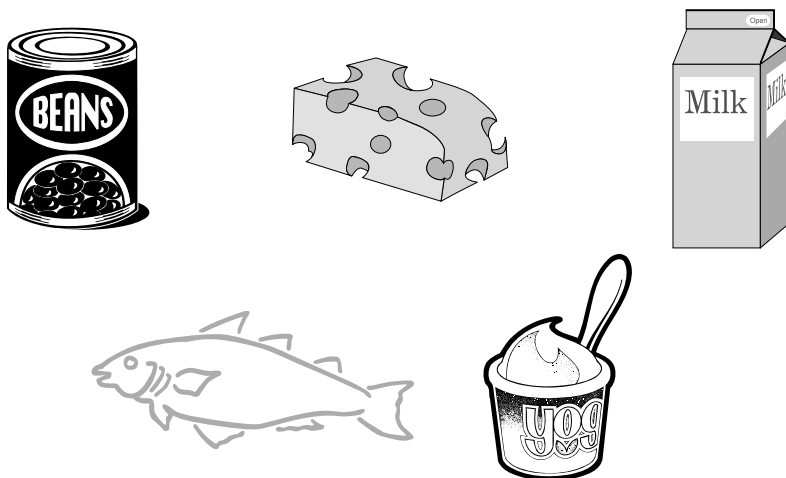

Eat a balanced diet with foods high in iron and calcium.



Key facts for Chapter 2



Lead can poison you and make you very sick.

Even a small amount of lead can make you sick.

Lead is dangerous when you breathe or swallow it.

Lead can cause permanent damage.

Children's developing brains and bodies are easily damaged by lead.

Even low levels of lead can cause permanent damage to a child.

Pregnant women and children are most easily lead poisoned.



Lead in your body

Lead can damage your body without your feeling any symptoms.

Lead poisoning can easily be mistaken for the flu.

Lead attaches to your red blood cells and travels through your body.

Lead can be stored in your body for more than 30 years.

Body burden is the amount of lead stored in your body.

Lead can be released from your bones and poison you.

Lead can harm many parts of your body—blood cells, heart, kidneys, nervous system, bone tissue, and reproductive organs.

Lead can cause men to have **problems having an erection**.

Lead can cause women to have **stillbirths** or **miscarriages**.



Blood tests

Blood tests find out how much lead is in your blood.

The tests used are: blood lead level test and zinc protoporphyrin (ZPP) test. The blood lead level test is the more accurate test.

Blood lead levels are measured in micrograms of lead per deciliter ($\mu\text{g}/\text{dL}$) of blood.

People can have different reactions to the same blood lead level.

Lead poisoning can be prevented.



Your work as a lead abatement worker will prevent future lead poisoning.

You can protect yourself against lead poisoning.



- Make sure your employer provides a safe workplace.
- Wash your hands and face carefully when you leave the work area.
- Use safe work practices that you will learn in this class.
- Eat a balanced diet that has enough iron and calcium.



For more information

These publications have more information on the topics covered in this chapter. Your instructor may have a copy of the publications marked with a star (*). You can order your own copy by calling 1-800-424-LEAD.

* CDC, *Preventing Lead Poisoning in Young Children* (October 1991).

* Environmental Defense Fund, *Legacy of Lead: America's Continuing Epidemic of Childhood Lead Poisoning* (March 1990).

* EPA, HUD, and CPSC, *Protect Your Family from Lead in Your Home* (June 2003).

Murphy, J. "Fetal Protection v. Women's Jobs: Case Is Before the Supreme Court," *The Nation's Health: Official Newspaper of the American Public Health Association* (November 1990).

National Lead Information Center, "Lead Poisoning and Your Children."



CHAPTER 3

LAWS, REGULATIONS, STANDARDS

Learning objectives	3-3
Laws	3-4
Other worker rights under OSHA	3-5
OSHA Interim Final Lead in Construction Standard fact sheet	3-7
Airborne lead exposure	3-7
Respirators and protective clothing	3-11
Your workplace	3-14
Training	3-15
Recordkeeping	3-16
Medical surveillance	3-16
Medical removal	3-19
Medical treatment	3-20
Title X fact sheet	3-22
Why was Title X passed?	3-22
The federal government is a “model landlord.”	3-23
Who has to be trained?	3-23
How should abatement work be done?	3-24
Does each state or tribe have its own certification program?	3-24
Are workers doing lead-abatement jobs protected?	3-25
When does lead-based paint become a hazard?	3-25
How is the government educating the public?	3-26
Who is making sure the laws really help solve the problem?	3-26
Have these laws been effective?	3-27
Your state or tribal laws	3-28
Key facts for Chapter 3	3-29
For more information	3-32





Learning objectives

In this chapter you will learn about

- the federal guidelines on lead
- the federal laws and regulations that protect workers and the environment
- your state, tribal, and local laws and regulations for lead.



The law is one tool for a safer and healthier job.

Laws

There are many laws and regulations on the books. Not everyone observes them. But laws give you many rights. **You can't fight for your rights unless you know what they are.** The law is one tool that can be used to secure a safer and healthier job.

The Occupational Safety and Health Administration (OSHA)—an agency of the Department of Labor—writes and enforces rules protecting workers on the job. OSHA issued an Interim Final Standard for Lead in Construction (29 CFR 1926.62) in May 1993. You will find a fact sheet that summarizes all the need-to-know information about the lead standard in this chapter. Other OSHA regulations may apply to the hazards of lead on construction sites. Your employer is required to provide additional training on the OSHA requirements.

Other OSHA rules you should know about are the Hazard Communication Standard (“Right-to-Know”) and the 11-C (“Nondiscrimination”) clause of the Occupational Safety and Health Act standards.

The Environmental Protection Agency (EPA) has issued rules protecting lead abatement workers, the public, and the environment. EPA’s training and work practices rules (what you can and cannot do when working on a lead abatement job) form the model most states/Indian tribes have used to write their lead program.

Some state and local governments have written laws protecting lead-abatement workers. The laws in your state/Indian tribe will be reviewed at the end of this section.

The Department of Housing and Urban Development (HUD) is responsible for setting requirements for federally owned or assisted housing and operating the Lead Hazard Control Grant Program for privately owned low-income housing. Most pre-1978 properties receiving HUD funds are subject to HUD requirements for lead-based paint. HUD has established guidelines for the evaluation and control of lead-based paint hazards in housing. For some projects, the guidelines are requirements. For other projects, they are recommendations only (not requirements). HUD has issued rules requiring training of rehab, renovation, and maintenance workers who do work on older homes or apartments on how to do their work lead-safely. These rules require clearance examinations of the worksite(s) to prove that the workers cleaned up properly.

HUD and EPA have issued rule to make sure the public is informed about lead-based paint and lead-based paint hazards in housing built before 1978.



Other worker rights under OSHA

As a construction worker, you have other OSHA rights that are contained in the Code of Federal Regulations (CFR). Below is a list of these rights and where to find them.

Right to a workplace free of recognized hazards (OSH Act, Public Law 91-596)

OSHA uses Section 5 in the Occupational Safety and Health Act to stop an employer from endangering a worker's health. It is sometimes called the "General Duty Clause." It can be applied when OSHA does not have a specific standard for a chemical or safety hazard.

Right to file a complaint (OSH Act, Public Law 91-596)

Under Section 11 (C) of the Occupational Safety and Health Act, you have a right to file a complaint with OSHA whenever you feel your health and safety rights are violated. You must file your complaint with OSHA within 30 days of the incident. You may request that OSHA keep your identity secret from your employer.

It is best not to file a complaint alone. Work through your union or co-workers. Contact your local area Committee on Occupational Safety and Health (COSH group) for assistance. A COSH group is a coalition of unions, workers, and professionals working together for safer and healthier working conditions.

Right to safety training (29 CFR 1926.21)

Your employer must train each worker on how to recognize and avoid unsafe conditions. Training must cover methods on how to work safely with hazardous substances—like lead—and in dangerous situations. You must be taught about personal hygiene procedures and about the use and limits of personal protective equipment.

Right to sanitation (29 CFR 1926.51)

Your employer must provide drinking water, toilet facilities, and adequate washing facilities for any work site where there is a contaminant, such as lead.

OSHA has many regulations to protect you.

**Right to respirator program (29 CFR 1910.134*)**

Before your employer hands you a respirator, he or she must have a respirator program. This program includes written procedures for choosing and using respirators and training all employees how to use and maintain respirators. Your employer must monitor the area to make sure all workers have the correct respirators. And your employer must make sure your respirator fits you properly.

The lead standard requires medical exams. You should not be assigned to tasks requiring use of respirators unless it has been determined that you are physically able to perform the work and use the equipment. The local physician shall determine what health and physical conditions are pertinent in order for you to wear a respirator. [29 CFR 1910.134(e)]

*You will receive more information on the requirements of the respiratory protection standard in the OSHA training provided by your employer.



OSHA Interim Final Lead in Construction Standard fact sheet

The OSHA Interim Final Lead in Construction Standard (1926.62) went into effect June 3, 1993. It applies to all workers doing construction work who may be exposed to lead on the job.

OSHA has developed a compliance document that will clarify the standard. You can obtain a copy of the compliance document by contacting the OSHA office in your area or by accessing the OSHA web site (www.osha.gov). Contact your state or regional OSHA office for an interpretation of the Construction Standard if necessary. (See the Glossary and Resources Section, Chapter 10, for a listing of OSHA offices.)

The sections of the standard which apply to the different parts of this fact sheet are listed in parentheses ().

Airborne lead exposure

How much lead am I allowed to breathe?

There are two legal limits for the amount of lead you are allowed to breathe. These limits are for the average amount of lead in the air over an 8-hour day:

Action Level—If you work in an area that contains lead at or above 30 micrograms per cubic meter ($\mu\text{g}/\text{m}^3$) of air, your employer must give you medical surveillance and training in the hazards of working with lead. The limit of $30 \mu\text{g}/\text{m}^3$ is called the Action Level (AL).

Permissible Exposure Limit—Your employer is not allowed to let you breathe in more than 50 micrograms of lead per cubic meter of air. It is called the Permissible Exposure Limit (PEL). If you work in an area with more lead in the air than the PEL, your employer must reduce your exposure.

If you are exposed to lead for more than 8 hours a day, the PEL must be adjusted. Divide 400 by the hours worked per day to get the new exposure limit.

How does my employer know how much lead is in the air?

Your employer **must** do an exposure assessment to determine the amount of lead in the air you are breathing. Exposure assessment can be **air sampling**, past exposure data from the same job or a similar job, or objective data (Section (d)(3) Basis of initial determination). Examples of objective data are product information and insurance information. Objective data are not often used. Conditions for each job, each day, and even each hour, are constantly changing. When conditions change, you cannot rely on objective data.

**OSHA lead in air
levels are:
AL = $30 \mu\text{g}/\text{m}^3$;
PEL = $50 \mu\text{g}/\text{m}^3$.**



Your employer must determine how much lead is in the air for each job type. For example, your employer may do exposure assessment on one scraper, one cleaner, and one person using a heat gun. When your employer does air sampling, your employer must do air sampling on each shift or the shift with the highest exposure. Your employer must also sample the air if any of the employees on the job think they are getting sick because of exposure to lead on the job.

How often does my employer need to sample the air?

Your employer must determine if you are breathing air at or above the Action Level ($30 \mu\text{g}/\text{m}^3$). If your exposure to lead is below the Action Level, your employer does not need to sample again unless the conditions of your job change. If your exposure to lead is at or above the Action Level but below the PEL ($50 \mu\text{g}/\text{m}^3$), then sampling must be done every six months. If the amount is above the PEL, then sampling must be done every three months.

Your employer must also sample every time the conditions of your job change. For example, your employer needs to sample each time you do an abatement job on a different type of building. (Section (d)(6) Frequency and (d)(7) Additional exposure assessments)

How can I find out the results of air sampling?

Your employer is required to give you the results of air sampling within five working days after receiving the results. (Section (d)(8) Employee notification)

Am I protected before air sampling is done?

YES! Certain tasks on construction jobs where lead-based paint is present are known to create large amounts of lead in the air. These tasks are called **lead-related tasks**. The OSHA Standard splits these lead-related task into three different classes. (Section (d)(2) Protection of employees during exposure assessment)

Class 1 tasks

- manual demolition of structures (for example, removing a wall)
- manual scraping (includes chemical stripping) or sanding
- using a heat gun
- power tool cleaning with dust collection systems
- spray painting with lead-based paint

When you do Class 1 tasks, your employer must protect you as if your lead exposure is above the PEL ($50 \mu\text{g}/\text{m}^3$) but not in excess of $500 \mu\text{g}/\text{m}^3$. Your employer must give you this protection until exposure assessment shows the exposure is less than the PEL. Even when the exposure is lower than $50 \mu\text{g}/\text{m}^3$, you can request a respirator. Your employer must give you one.

Certain tasks on construction jobs create large amounts of lead in the air.



Class 2 tasks

- using lead-based mortar
- burning lead
- rivet busting
- power tool cleaning without dust collection systems
- cleanup activities where dry expendable abrasives are used
- moving or tearing down the enclosure used for abrasive blasting

Your employer must protect you when you do Class 2 tasks as if your lead exposure is between 10 times the PEL ($500 \mu\text{g}/\text{m}^3$) and $2,500 \mu\text{g}/\text{m}^3$. He or she must give you higher protection until exposure assessment shows that your exposure is less than $500 \mu\text{g}/\text{m}^3$. If your exposure is lower, you must still be protected. Your employer must provide you with a respirator that protects you from the lead level to which you are being exposed. You can use the chart on page 3-10 and the exposure assessment to find the right respirator for the job.

Class 3 tasks

- abrasive blasting
- welding
- cutting
- torch burning

Your employer must protect you when you do Class 3 tasks as if your lead exposure is above 50 times the PEL ($2,500 \mu\text{g}/\text{m}^3$). Your employer must give you this higher protection until exposure assessment shows that your exposure is below this level. If your exposure is lower, you must still be protected. Your employer must provide you with a respirator that protects you from the lead level to which you are being exposed. You can use the chart on page 3-10 to find the right respirator for the job.

What does my employer have to do?

If you will be exposed at or above the AL or you will do any of the lead-related tasks in Classes 1, 2, or 3, your employer must provide the following for workers: (Section (d)(2)(v)(A)-(F))

- training on the hazards of working with lead
- a place for hand and face washing
- blood tests reviewed by a doctor
- HEPA vacuums

Your employer must provide you with a respirator that protects you from the lead level to which you are being exposed.

**SOME RESPIRATORS LEGAL FOR LEAD WORK**

Task Class	MUC*	Respirator Types
Class 1	500 µg/m ³	<ul style="list-style-type: none">• Half-mask, air-purifying with HEPA** filters
Class 2	1,250 µg/m ³	<ul style="list-style-type: none">• Loose-fitting hood or helmet PAPR with HEPA filters• Hood or helmet with supplied air continuous flow• Type CE continuous flow
Class 2	2,500 µg/m ³	<ul style="list-style-type: none">• Full-face, air-purifying with HEPA filters• Tight-fitting PAPR with HEPA filters• Full-face, supplied air, pressure demand• Half-mask or full-face, supplied air, continuous flow
Class 3	50,000 µg/m ³	<ul style="list-style-type: none">• Half-mask, supplied air, pressure demand
Class 3	100,000 µg/m ³	<ul style="list-style-type: none">• Full-face, supplied air, pressure demand• Type CE pressure demand
Class 3	100,000+ µg/m ³	<ul style="list-style-type: none">• Full-face, SCBA, pressure demand

*MUC stands for “Maximum Use Concentration,” which means the highest amount of lead in the air for which the respirator can be used.

**HEPA: high efficiency particulate filter means a filter that is 99.97 percent efficient against particles of 0.3 micron size or larger.

Remember: Some specific tasks require minimum respiratory protection until your employer determines your actual exposure level (i.e., the amount of lead in the air you are breathing). However, the appropriate level of respiratory protection provided for any lead activity should be based upon the airborne concentration present in the workplace.



If you will be exposed above the PEL or you will do any of the lead-related tasks in Classes 1, 2, or 3, your employer must provide the following for workers, (in addition to those required if you exceed the AL): (Section (d)(2)(v)(A)-(F))

- the correct respirator (see the table on page 3-10)
- personal protective clothing and equipment
- an area to change into and out of your work clothes
- a place for hand and face washing
- a place where you can shower at the end of the day, if feasible
- blood tests reviewed by a doctor
- training on the hazards of working with lead
- a lead-safe area for eating and drinking
- warning signs around the work area

Does my employer have to reduce my exposure to the lead in the air?

YES! Your employer must do everything possible to reduce your exposure, for example:

- Use materials or tools which make less lead dust or fumes.
- Change the way you do a job so you create less dust and fumes.
- Rotate schedules so worker exposure to lead is less than a few hours a day.
- Provide you with a respirator.

Your employer must list in writing all the ways he or she is trying to reduce your exposure to lead. This is called a compliance program. (Section (e)(2) Compliance program)

Respirators and protective clothing

When must I wear a respirator?

According to the OSHA Standard, you are only required to wear a respirator if you are doing a Class 1, 2, or 3 task or if air sampling shows you are exposed above the PEL ($50 \mu\text{g}/\text{m}^3$). But if you are exposed to any amount of lead, the regulations say you can request a respirator from your employer, and your employer is required to give you a respirator. This means you can still get a respirator even if you are not exposed to lead above the PEL or doing any of the lead-related tasks.

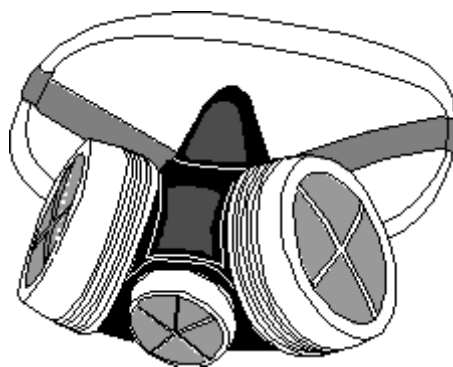

Respirators and protective clothing will reduce your lead exposure.



The respirator you use will depend on the amount of lead in the air and the job you are doing.

A physician or PLHCP must determine who can and cannot use or wear a respirator safely.

Your employer must provide a respirator for any employee exposed to lead who asks for one. You may want to have this extra protection, especially if you are planning to have children. OSHA recommends that both males and females that are of childbearing age not exceed a blood lead level of 30 µg/dL (Appendix C, Section II).

Whenever you are exposed above the PEL, you can always ask your employer for a Powered Air Purifying Respirator (PAPR). If you are exposed above the PEL, your employer must, by law, provide you with a PAPR—if you ask for it and if it protects you enough. If a PAPR is not protective enough for the job—for example, abrasive blasting—then your employer must provide you with a better respirator that is suitable for this type of work. (Section (f)(1)(iv) Respiratory protection)

What type of respirator can I use?

The respirator you use will depend on the amount of lead in the air and the job you are doing. The standard says you must have a respirator at least as protective as those listed in the table on page 3-10. You can always ask your employer for a Powered Air Purifying Respirator (PAPR). By law, your employer must give you a PAPR if you are exposed above the PEL and you ask for one—and if it provides enough protection. Sometimes a PAPR will not protect you enough—for example, if you were doing abrasive blasting. In that case, your employer must give you a better respirator, such as a full-face, supplied air, pressure demand respirator. Any respirator you use must have a stamp of approval by National Institute of Occupational Safety and Health (NIOSH) or the Mine Safety and Health Administration (MSHA). (Section (f), Table 1 *Respiratory Protection for Lead Aerosols*)

What do I need to do before I wear a respirator?

A physician or other licensed health care professional (PLHCP) (e.g., registered nurse) must determine who can and cannot use or wear a respirator safely. This medical evaluation consists of the written or verbal completion of Appendix C of the lead in construction standard (29 CFR 1926.62) by the PLHCP. Your employer must pay for the medical evaluation and any testing recommended by the PLHCP. You also need fit testing and training on how to use your respirator.

What personal protective equipment do I need other than a respirator?

If you are working in an area with lead above the PEL, or if you are doing any of the tasks listed under Class 1, 2, or 3, your employer must give you protective work clothing. (Section (g) Protective work clothing and equipment) This clothing should include

- coveralls
- gloves
- disposable shoe coverings
- face shield or vented goggles
- hat (adequate head protection based on the hazards present in the work area)



Who is responsible for providing and cleaning my protective clothing ?

If you are exposed at or below the PEL ($50 \mu\text{g}/\text{m}^3$), your employer is not required to provide you with protective clothing. If you are exposed above the PEL but below $200 \mu\text{g}/\text{m}^3$ —or you are doing a Class 1 task and no exposure assessment has been completed—your employer must wash and dry protective clothing or give you new clothing **every week**. If you are exposed at or above $200 \mu\text{g}/\text{m}^3$, your employer must provide clean or new protective clothing **every day**. If you are doing a Class 2 or 3 task, and an exposure assessment for the task has not been completed, your employer must assume that you are being exposed at the higher levels associated with these tasks. The employer must provide clean or new protective clothing **every day until the exposure assessment determines** that your exposure is less than $200 \mu\text{g}/\text{m}^3$.

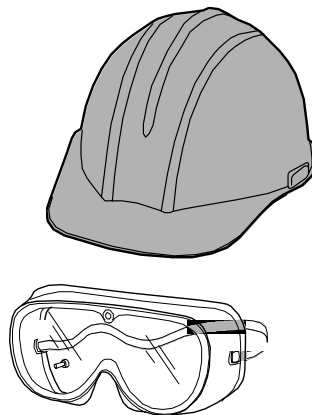

Many employers provide **disposable suits**. These suits are easily torn. You should inspect your protective clothing regularly for tears or rips. If your suit tears or rips and you cannot repair it, you must get a new protective suit. Some employers provide **reusable, non-disposable protective clothing**. This clothing is usually more durable than the disposable suits, but if it does rip or tear, have it repaired immediately to minimize your chances of being contaminated. If you are given non-disposable protective clothing, your employer is responsible for cleaning, drying, and repairing it. (Section (g)(2) Cleaning and replacement)

Where should I put my used protective clothing?

Your employer must have a closed container in the change area for used protective clothing. The container must be labeled as follows:

CAUTION: Clothing contaminated with lead.
DO NOT REMOVE DUST BY BLOWING OR SHAKING.
Dispose of lead-contaminated wash water in accordance
with applicable local, state, or federal regulations.

This helps to prevent your family and other people living in the community from being exposed to lead. The standard says your employer cannot let you leave the work area with protective clothing on.



Use only a HEPA vacuum when cleaning up lead dust.

Never eat, drink, smoke, chew, or apply cosmetics in a lead work area!!

Your workplace

How clean must we keep our job site?

The standard says you must keep all surfaces as free of lead as possible. You must clean up floors and other surfaces with a vacuum or other method that minimizes the likelihood of lead getting into the air. This vacuum must have a High Efficiency Particulate Air (HEPA) filter. Only use shoveling, dry-sweeping, wet-sweeping, or brushing if your employer shows that vacuuming, or other equally effective method, does not work to pick up the dust on your job site.

Compressed air shall not be used to remove lead from any surface unless used in conjunction with proper ventilation and air filtration. (Section (h) Housekeeping)

Can we eat or drink on the job?

NO! Your employer must **not** allow you to eat, drink, smoke, chew tobacco, or apply cosmetics in the work area where your exposure to lead is above the PEL. Your employer must have a place where anyone exposed above the PEL can eat and drink safely, away from lead. Your employer must make sure that you wash your hands and face before eating, drinking, smoking, or applying cosmetics. (Section (i) Hygiene facilities and practices)

Where can we change our clothes and wash?

Whenever you work with lead, your employer must have a place for you to wash your hands and face. Your employer must make sure that you wash your hands and face at the end of each work shift.

The standard says your employer must have places where anyone exposed above the PEL or doing any of the lead-related tasks (Class 1, 2, or 3) can change in and out of their work clothes. Your employer must have a place where anyone exposed above the PEL can shower, if feasible. OSHA officials have said that if your employer decides having a shower is not feasible, he or she must be able to explain his or her reasoning to any OSHA inspector who comes on the site. (Section (i)(2) Change areas)

**Does my employer have to post warning signs in the work area?**

Your employer must post warning signs in the work area where employees are exposed above the PEL. (Section (m) Signs) The signs must say

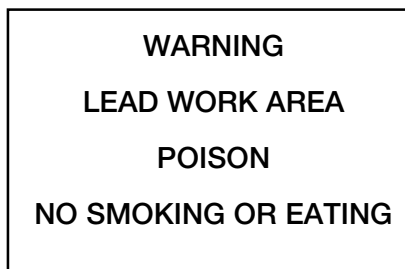

Your employer must train you on the hazards of lead and how to protect yourself.

Training**How can workers find out about the hazards of lead?**

The OSHA standard says that employers must provide training to anyone

- working with lead at or above the Action Level ($30 \mu\text{g}/\text{m}^3$);
- doing any of the tasks listed under Class 1, 2, or 3;
- using any lead compounds that cause eye or skin irritation.

(Section (l) Employee information and training)

What does the training about lead have to include?

The annual training must include information on

- OSHA's hazard communication standard (29 CFR 1926.59) including requirements for warning signs and labels, MSDS, and employee information and training;
- OSHA Interim Final Lead in Construction Standard;
- jobs that expose workers to lead above the Action Level;
- respirators: their use and limitations, the different types, and the importance of a proper fit;
- medical surveillance and medical removal protection programs;
- ways your employer can reduce your exposure to lead;
- what your employer is doing to reduce your exposure to lead;
- contents of employer's compliance program (if $> 50 \mu\text{g}/\text{m}^3$);
- instructions not to use chelating agents.



OSHA says that you have a right to see your records:

- medical;
- air sampling.

Recordkeeping

What records does my employer have to keep?

Your employer must keep records of

- all exposure assessments done on your job site;
- the types of respiratory protection worn on your job site;
- names and social security numbers of all employees;
- all medical surveillance done on employees;
- all training done for employees;
- all cases of employees being "medically-removed" from the workplace.



All records must be kept for at least 30 years (except training records—they must be kept for at least one year after you leave that employer). (Section (n) Recordkeeping).

Do I have the right to see any of these records?

YES! You have the right to see any of the air sampling results or any other types of exposure assessments done on your job site. You have the right to have a copy of your medical exam and blood test results. Your employer is required to send a copy of your medical records to anyone you choose. Any requests to send your medical records to someone else should be in writing.

Medical surveillance

Special medical exams called medical surveillance are required when you work with lead. (Section (j) Medical surveillance) There are two types of medical surveillance:

- initial medical surveillance
- medical surveillance program

Initial medical surveillance

Initial medical surveillance consists of blood tests that check the amount of lead in your blood. This test is also called **biological monitoring**. The two blood tests used in the biological monitoring are the blood lead level test and the zinc protoporphyrin (ZPP) test. You need medical surveillance if you do any of the tasks in class 1, 2 or 3 listed in this standard or if you are exposed to lead on the job any one day at or above the Action Level.



On-going medical surveillance program

You need a medical surveillance program if you are or may be exposed to lead on the job at or above the Action Level for **more than 30 days** in any continuous 12-month period. If you are a lead-abatement worker, you can be exposed to lead above the Action Level for 30 or more days in a year. When you expect to do lead-abatement work for at least 30 days, you should take part in a medical surveillance program.

The ongoing medical surveillance program has three types of exams. The doctor must follow the standard and provide

- blood tests for biological monitoring;
- a six-part medical exam;
- a medical exam and consultation.

Blood tests for biological monitoring

The blood lead level and ZPP tests are required when

1. you begin working with lead and every two months for the first six months, and then every six months as long as you are working with lead at or above the Action Level for 30 or more days within a year's time period;
2. your blood lead level results are at or above 40 µg/dL—you must be tested at least every two months until two consecutive blood lead level results are below 40 µg/dL;
3. your blood lead level results are at or above 50 µg/dL—you must be tested again within two weeks. If the second test result is at or above 50 µg/dL, you must be medically removed (defined on page 3-19) and tested at least every month until you reach a blood lead level of 40 µg/dL or less on two separate testing dates. The tests must be taken at least 30 days apart.

Six-part medical exam

Your employer must make available to you the required six-part medical exam in the medical surveillance program whenever you will be working with lead at or above the Action Level for 30 or more days and your blood lead level results are 40 µg/dL or above. (Section (j)(3)(ii) Content) This exam consists of the following:

1. interview about your work and medical history covering:
 - a. past lead exposures
 - b. personal habits like smoking and hygiene
 - c. previous medical problems with the kidneys, heart, nerves, blood, stomach, intestines, and reproductive organs
2. complete physical exam to look at your

Blood tests are the best way of knowing if you've been exposed to lead.



- a. blood
 - b. teeth and gums
 - c. stomach and intestines
 - d. kidneys
 - e. nerves
 - f. brain
 - g. heart
 - h. lungs
3. blood pressure check
 4. blood tests which will show
 - a. blood lead level
 - b. ZPP
 - c. hemoglobin & hematocrit (anemia test)
 - d. blood urea nitrogen
 - e. serum creatinine (kidney test)
 5. routine urinalysis (kidney and protein check)
 6. any additional test that the doctor needs to do to determine how lead has affected or could affect you. Pregnancy testing and male fertility testing must be provided if you request them.

**Medical exam and consultation**

You have the right to a medical exam and consultation whenever you will be working with lead at or above the Action Level for 30 days or more and

- anytime you are working with lead and you feel sick with any of the signs and symptoms of lead poisoning;
- yearly when you have a blood lead level at or above 40 µg/dL;
- whenever you are concerned about having a healthy baby;
- if you have difficulty breathing while wearing a respirator.

You need to notify your employer that you want the medical exam and consultation. The content of this medical exam and consultation is determined by the doctor. (Section (j)(3) Medical exam and consultation)

Who must provide medical surveillance?

Medical surveillance must be provided by your employer.

Your employer must provide medical surveillance for you at no cost to you, the worker—and at a reasonable time and place.



All medical examinations and procedures must be supervised or performed by a licensed physician. Your employer must notify you of the results of the exam within five working days. This is called “**notification.**” You may have another doctor review the findings and provide a second exam. The employer must pay for the second review. This is called “**multiple physician review.**”

What does multiple physician review mean?

If you are not comfortable with the available doctor or do not agree with the doctor’s findings, you can request a second medical exam with a doctor of your choice. This request must be made within 15 days after you receive your copy of the initial medical exam results. Your employer must pay for the second exam.

If the doctors do not agree, they are asked to talk with each other. If there is still no agreement, then a third doctor selected by the two previous doctors will review the findings and conduct any necessary exams. The third doctor gives a written recommendation to the employer. The third opinion is followed unless you and your employer jointly agree to follow the recommendation of either of the previous doctors. (Section (j)(3)(iii) Multiple physician review mechanism)

Medical removal

What is medical removal?

Medical removal means that you are removed from the lead exposure on your job. The standard states you must be removed if your blood lead levels get too high. Medical removal can prevent you from getting severe lead poisoning. Removing you from the lead exposure gives your body time to get rid of the lead. Sometimes this is enough to bring the blood lead level down. Medical removal is a way to protect you from becoming lead poisoned. There are two times that you may be medically removed:

- **elevated blood lead level**

If your blood lead level reaches 50 µg/dL, for the periodic blood test and the follow-up blood test, you must be removed from exposure to lead at or above the Action Level. It is dangerous for you to work with lead when your blood lead level is so high. **You cannot wear a respirator to lower your exposure when your blood lead level is so high.** If you get more lead into your body, you could become lead poisoned. Your employer must provide you with a job with no lead exposure at or above the Action Level. If your employer cannot, he/she must pay you your normal wages until your blood lead level is at 40 µg/dL on two separate tests. You then return to your former job. If your blood lead level remains above 40 µg/dL, your wages must be paid as long as the job exists or up to 18 months. **This is called medical removal protection.**

If the lead level in your blood gets too high, you should not work in a lead work area until your doctor says it’s okay.



- **final medical determination**

Final medical determination means the doctor has given a written medical opinion to remove you from lead exposure. The doctor believes that you have a medical problem that will be affected by lead exposure. The doctor believes that the risk to your health is high. **The doctor must inform the employer of the medical recommendation regarding working with lead.**

The doctor does not tell the employer what the medical problem is, but states that you are at high risk of ill health with lead exposure.

You may return to work with lead when the doctor determines that you no longer have a medical problem that puts you at high risk of ill health with lead exposure. The doctor must put the medical opinion in writing. You then return to your former job. While you are unable to work with lead, your employer must provide you with another job where your lead exposure is not at or above the Action Level. If another job is not available, your employer must pay your wages for as long as the job exists or up to 18 months.

A doctor may use a final medical determination if you say you want to have children and your blood lead level is 30 µg/dL or higher. You will then be placed on medical removal protection. OSHA recommends that a Maximum Permissible blood lead level of 30 µg/dL should not be exceeded in males and females who wish to have children. (Section (k)(1) Temporary medical removal and return of an employee)

What is medical removal protection?

Medical removal protection means that your job will be protected if you must be medically removed from your lead abatement job. Under the OSHA Lead Standard, your employer must pay your salary and benefits and maintain your seniority while you are medically removed. This medical removal protection will last as long as the job exists or up to 18 months. (Section (k)(2) Medical removal protection benefits)

Medical treatment

What is the treatment for lead poisoning?

Chelation therapy is the medical treatment for severe lead poisoning. Chelation therapy is when a drug that is attracted to metals (such as lead) is given to someone with high levels of lead in their blood. Most chelating drugs are now given orally (they used to be given by injection). The drug then gets into the blood stream. It binds to the metal in the blood; the metal and the drug are then passed out of the body through the kidneys in the urine. It is a risky treatment.

Whenever possible, get a second medical opinion to determine whether you need chelation treatment.



Chelation can get rid of some of the lead in your body, but it can be harmful to your health. Chelation is a serious medical treatment. The drug not only removes the lead from your blood, but also other metals that the body needs, such as iron and zinc. When possible, you want to know that at least two doctors think it is necessary for you to have it. The second doctor should be a doctor that you know and trust. This second opinion is paid for by your employer, when you request it. This is when the multiple physician review is most helpful.

Prophylactic chelation means giving chelating drugs to someone to try and prevent lead poisoning. Chelating drugs will only help remove lead from your body after you have been poisoned. Chelating drugs will not protect anyone from lead poisoning. It is illegal for your employer or anyone employed by your employer to give you chelating drugs.

Chelating drugs are dangerous to your health. They can hide lead poisoning that may be happening to you. The chelating drugs may also make your body take in lead more easily. (Section (j)(4) Chelation)

Taking chelating drugs as a preventative treatment is prohibited and illegal.



Title X was designed to reduce lead-based paint hazards and lead poisoning.

Title X fact sheet

The Residential Lead-Based Paint Hazard Reduction Act of 1992 (Title X [“ten”]) was established by Congress to reduce the risk of lead poisoning in Federal Housing stock. Some of the general purposes of this law were to

- prevent lead poisoning;
- insure that Federal policies incorporate lead hazard reduction measures;
- educate the public;
- develop an infrastructure capable of dealing with lead in housing (e.g., trained and certified professionals such as lead abatement contractors and workers).

Most of the lead regulations from federal agencies such as the Environmental Protection Agency (EPA), the Department of Housing and Urban Development (HUD), and the Occupational Safety and Health Administration (OSHA) were developed based on direction found in Title X. This law is the cornerstone of the national lead program.

Title X required different government agencies (such as HUD and EPA) to help reduce the amount of lead poisoning in this country. This fact sheet lists some of the important parts of Title X.

Why was Title X passed?

The United State Congress received information that

- an estimated three million American children under the age of six had at least low-level lead poisoning (that number has been reduced to less than one million in part due to the laws and practices instituted since the passage of Title X);
- lead poisoning in children may cause reading and learning disabilities, hyperactivity, and behavior problems;
- ingesting lead dust from deteriorating lead-based paint is the most common cause of lead poisoning;
- homes built before 1980 contained more than 3 million tons of lead in the form of lead-based paint;
- as many as 3,800,000 American homes had chipping or peeling lead-based paint;
- the dangers of lead-based paint hazards can be reduced by permanently abating those hazards or by using interim controls to prevent paint deterioration;



Since Title X was passed, the government has taken many steps to reduce lead-based paint hazards (the regulations and an explanation of what each requires are listed in this chapter).

Title X was designed to eliminate lead-based paint hazards **before** they poison children. In the past, many agencies only got rid of lead-based paint **after** a child had been poisoned.

What was the law designed to do?

The law was designed to

- develop a system of trained people (including lead inspectors, risk assessors, supervisors, contractors, project designers, and abatement workers) to evaluate and reduce lead hazards;
- reduce childhood lead poisoning;
- use government funds in the most cost-effective way to eliminate lead-based paint hazards;
- educate the public concerning the hazards and sources of lead poisoning.

The federal government is a “model landlord.”

The federal Lead Safe Housing Rule (which became effective September 15, 2000) requires that actions be taken to address lead hazards in all housing receiving HUD assistance. The actions required depend upon the nature and amount of the assistance provided by HUD. For example, housing receiving funds for rehabilitation are subject to different requirements than housing receiving project-based rental assistance (i.e., the financial assistance is tied to a specific residential property with a specific location).

Anyone purchasing or renting a housing unit built before 1978 must be given a lead hazard information pamphlet: *Protect Your Family from Lead in Your Home*. They must also be notified by the owner of any known information on lead-based paint or lead-based paint hazards inside or outside of the house or apartment.

Who has to be trained?

Title X required EPA to issue specific requirements for how contractors, workers, supervisors, inspectors, risk assessors, and project designers will be trained in lead-based paint activities. These requirements also say how abatement contractors, workers, supervisors, and paint inspectors and risk assessors will be certified. EPA has developed model course curricula for each of the disciplines listed. Most training providers use EPA’s curricula. As part of the EPA program, lead training programs must also be accredited. Only EPA- or state/Indian Tribe-approved training will qualify for certification.

HUD's Lead Safe Housing Rule requires that lead hazards be addressed in all housing receiving HUD assistance.



Many renovation and maintenance workers must be trained in lead-safe work practices.

There are established work practices that you must followed on a lead abatement job.

Certification and licensing requirements for lead workers apply in all states and tribes.

HUD's Lead Safe Housing Rule requires renovation, rehab, and maintenance workers who will disturb lead-based paint during jobs done in housing receiving HUD assistance to be trained in lead-safe work practices. HUD and EPA have developed several courses to train these workers in lead-safe work practices.

How should abatement work be done?

EPA established work practice standards which must be followed when doing abatement (and lead-based paint inspections, or risk assessments):

- Companies and individuals doing the work must be certified or licensed by the state, Indian tribe, or EPA.
- abatement must be performed according to the following procedures:
 - a certified supervisor is required for each abatement project and must be on-site during all work site preparation and during the post-abatement cleanup of work areas and available by telephone, pager or answering service and to be present at the work site within two hours (some states require the supervisor to be on-site *at all times* during the project).
 - the supervisor and firm must be sure that all abatement activities are conducted according to the requirements of all Federal, State/Tribal, or local requirements.
 - EPA and the state/tribes require notification of the beginning of lead-based paint abatement activities in a residential dwelling or child-occupied facility.
 - a written occupant protection plan must be prepared for all abatement projects
 - specific work practices are prohibited;
 - soil must be either removed and replaced or permanently covered;
 - there are specific post-abatement procedures required (including a visual inspection and clearance dust sampling) that must be done by a certified lead-based paint inspector or risk assessor.

Does each state or tribe have its own certification program?

Many states have their own certification or licensing program which is approved by EPA. EPA runs the certification program in states and Indian tribes that do not have their own programs. Because all state programs must be based on EPA's model plan, each state's program should be the same or very similar. However, some states' rules are different. The course instructor will address the differences that may exist between your state's or tribe's rules and EPA's rules. Make sure this course and any others you take are approved by the state(s)/Indian tribe(s) in which you work.

**Are workers doing lead-abatement jobs protected?**

The OSHA Interim Final Lead in Construction Standard became law on June 3, 1993. This standard includes specific requirements for protecting workers doing lead-abatement jobs.

When does lead-based paint become a hazard¹?

EPA has issued standards on

- the conditions of lead-based paint that are a hazard;
- the level of lead in dust allowed on the floors or windows before it is considered a hazard;
- the level of lead allowed in bare residential soil before it is considered a hazard.

Paint-lead hazards

EPA has defined under what conditions lead-based paint in a dwelling becomes hazardous:

- lead-based paint on friction surfaces that are subjected to abrasion (rubbing of painted surface against painted surface as with double-hung window sashes) and where dust-lead hazards (see below) are present;
- lead-based paint on impact surfaces (e.g., floors, door stops, chair rails) that is damaged or deteriorated;
- any chewable lead-based painted surface on which there is evidence of teeth marks;
- any other deteriorated lead-based paint.

Dust-lead hazards

EPA has defined what dust levels would indicate a dust-lead hazard. These levels are:

Location	Amount of Lead
Bare or carpeted floors	40 µg/ft ²
Interior window sills (stools)	250 µg/ft ²

Damaged or deteriorated lead-based paint is a hazard.

EPA has defined dangerous levels of lead in dust and bare soil.

¹ Lead-based paint hazards are usually identified during a lead risk assessment. More information on lead risk assessments and other lead hazard evaluations is found in Chapter 4.)



In addition, EPA has established clearance lead-dust levels. The clearance levels must be met after abatement or federally-assisted rehab or renovation activities have been performed:

Location	Amount of Lead
Bare or carpeted floors	40 µg/ft ²
Interior window sills (stools)	250 µg/ft ²
Window troughs	400 µg/ft ²

Soil-lead hazards

Finally, EPA issued standards on the levels of lead in **residential** bare soils that constitute a soil-lead hazard.

The two different levels established are

Location	Amount of Lead
play areas	400 µg/g (ppm)
other areas of the yard	average of 1,200 µg/g (ppm)

Your supervisor or employer is required to make sure the project is in compliance with the applicable standards.

How is the government educating the public?

Title X required EPA and HUD to issue regulations which require property owners to give each person buying or renting a property built before 1978:

- an EPA lead hazard information pamphlet: *Protect Your Family From Lead in Your Home*;
- any information about lead-based paint hazards in the property;
- for homes built before 1978, a statement in the sales/lease contract warning about the hazards of lead-based paint.

In addition, before a home built before 1978 is sold, the buyer must be given at least ten days to conduct an inspection or risk assessment for lead-based paint hazards. This requirement became effective for everyone in December 1996.

Before starting renovation that will disturb more than two square feet of paint in housing built before 1978, home remodeling or renovation contractors are required by EPA to give a lead hazard information pamphlet to the owner and occupant.

Who is making sure the laws really help solve the problem?

Title X required the HUD Secretary and the EPA Administrator to set up a task force of federal agencies and other organizations with knowledge about lead-based paint activities. This task force has made recommendations to EPA and HUD on developing standards and dealing with the concerns of property owners.

EPA and HUD are educating the public about lead-based paint hazards.



Have these laws been effective?

Yes! Since the passage of Title X and the implementation of these laws, there have been many successes in reducing lead poisoning in children and lead-based paint hazards in housing. These include:

- a significant reduction in the number of residences with lead-based paint and lead-based paint hazards;
- fewer children have too much lead in their blood;
- thirty-seven states now have lead certification or licensing laws (approved by EPA);
- there are thousands of trained and certified lead inspectors, risk assessors, contractors, and workers;
- HUD lead hazard control grants are now active in over 200 cities;
- thousands of maintenance, renovation, and remodeling workers have been trained in lead-safe work practices;
- HUD published the *Guidelines for the Evaluation and Control of Lead-based Paint Hazards in Housing* and modernized lead hazard control requirements in all federally-assisted housing;
- there is overall increased public awareness of lead hazards in housing and how to prevent them.

Since Title X was passed by Congress, there have been many successes in reducing lead-based paint hazards in housing and lead poisoning of children and workers.



Your state or tribe may have lead regulations that are different from the federal.

Your state or tribal laws

Your instructor should provide you with lead-based paint information that applies to the state or tribe in which you work or live. Some cities and counties have lead laws that may apply to the job you are doing. This information may be inserted here. Or, you may take some notes on this page.



Key facts for Chapter 3

Key The law is one tool that can be used to secure a safer and healthier job.

The Occupational Safety and Health Administration (OSHA), an agency of the Department of Labor, writes and enforces rules protecting workers on the job.

The Environmental Protection Agency has issued rules protecting lead abatement workers, the public, and the environment.

The Department of Housing and Urban Development (HUD) has established guidelines for lead-based paint abatement projects in housing. They have also issued rules to protect workers and occupants during and after rehab, renovation, and maintenance in federally-assisted housing.

Key OSHA has set legal limits for airborne lead exposure.

There are two legal limits for the amount of lead you are allowed to breathe: the Action Level, at or above $30 \mu\text{g}/\text{m}^3$; the Permissible Exposure Limit, more than $50 \mu\text{g}/\text{m}^3$ per cubic meter of air.

Your employer must do an exposure assessment to determine the amount of lead in the air you are breathing.

Your employer must determine how much lead is in the air for each job type.

Certain tasks on construction jobs where lead-based paint is present are known to cause large amounts of lead in the air. These tasks are called “lead-related tasks.”

Key If you will be exposed above the PEL or you will do any of the lead-related tasks in Classes 1, 2, or 3, your employer must provide the following for workers:

- the correct respirator;
- personal protective clothing and equipment;
- an area to change into and out of your work clothes;
- a place for hand and face washing;
- a place where you can shower at the end of the day, if feasible;
- blood tests reviewed by a doctor;
- training on the hazards of working with lead;
- a lead-safe area for eating and drinking;
- warning signs around the work area.



🔑 When must I wear a respirator?

According to the OSHA Standard, you are only required to wear a respirator if you are doing a Class 1, 2, or 3 task or if air sampling shows you are exposed above the PEL ($50 \mu\text{g}/\text{m}^3$).

You can request a respirator from your employer, and your employer is required to give you a respirator.

If you are exposed above the PEL, your employer must provide you with a Powered Air Purifying Respirator (PAPR)—if you ask for it and if it provides enough protection for the lead levels to which you are exposed.

The respirator you use will depend on the amount of lead in the air and the job you are doing.

🔑 What personal protective equipment do I need other than a respirator?

- coveralls
- gloves
- disposable shoe coverings
- face shield or vented goggles
- hat (adequate head protection based on the hazards present in the work area)

🔑 You must clean up floors and other surfaces equipped with a vacuum with a High Efficiency Particulate Air (HEPA) filter.

🔑 You must not eat, drink, smoke, chew tobacco, or apply cosmetics in the work area.

🔑 Whenever you work with lead, your employer must have a place for you to wash your hands and face.

🔑 Your employer must train you on the hazards of lead and how to protect yourself. Employers must provide training to anyone

- working with lead at or above the Action Level ($30 \mu\text{g}/\text{m}^3$);
- doing any of the tasks listed under Class 1, 2, or 3;
- using any lead compounds that cause eye or skin irritation.

🔑 Your employer must keep records of

- all exposure assessments done on your job site;
- the types of respiratory protection worn on your job site;
- names and social security numbers of all employees;
- all medical surveillance done on employees;



- all training done for employees;
- all cases of medical removal of employees.

You have a right to see your records.

Special medical exams are required when you work with lead. These exams are called **medical surveillance**. There are two types: **initial medical surveillance** and **medical surveillance program**.

Initial medical surveillance is blood tests that check the amount of lead in your blood.

You need a medical surveillance program if you are or may be exposed to lead on the job at or above the Action Level for more than 30 days in any continuous 12-month period.

Your employer must provide medical surveillance for you at no cost to you, the worker—and at a reasonable time and place.

Medical removal is a way to protect you from becoming lead poisoned.

There are two times that you may be medically removed: if your blood lead level reaches 50 µg/dL or if the doctor has given a written medical opinion to remove you from lead exposure.

Medical removal protection means that your job will be protected if you must be medically removed from your lead abatement job.

Chelation is the medical treatment for severe lead poisoning. Chelating drugs are dangerous to your health.

"Residential Lead-Based Paint Hazard Reduction Act of 1992" is also known as Title X (Title "Ten").

Title X was designed to reduce lead-based paint *hazards* and *lead poisoning*.

Training is required for nationwide for lead workers. Check to see whether EPA or the state/tribe in which you work is running the program.

There are work practice standards which must be followed when doing abatement.

The public is being educated about the dangers of lead-based paint hazards.

EPA has set levels of dangerous levels of lead in dust and bare soil and defined lead-based paint *hazards*.

You must clean up carefully after each job and pass clearance dust-wipe testing.

Your state/Indian tribe may have lead regulations that are more stringent than EPA's.



For more information

These publications have more information on the topics covered in this chapter. Your instructor has a copy of the publications marked with a star (*). You can order your own copies by calling 1-800-424-LEAD.

*EPA, *Lead: Identification of Dangerous Levels of Lead; Final Rule*; 40 CFR Part 745 (January 2001).

EPA, *Regulatory Status of Waste Generated by Contractors and Residents from Lead-based Paint Activities Conducted in Households*, Interpretive Memorandum (July 2000).

EPA, *Lead: Requirements for Hazard Education Before Renovation of Target Housing; Final Rule*; 40 CFR Part 745 (June 1998).

*EPA, *Lead: Requirements for Lead-Based Paint Activities in Target Housing and Child-Occupied Facilities*; 40 CFR Part 745 (August 1996).

EPA and HUD, *Lead: Requirements for Disclosure of Known Lead-Based Paint and/or Lead-Based Paint Hazards in Housing; Final Rule*; 40 CFR Part 745 and 24 CFR Part 35 (March 1996).

*HUD, *Requirements for Notification, Evaluation and Reduction of Lead-Based Paint Hazards in Federally Owned Residential Property and Housing Receiving Federal Assistance; Final Rule* (September 1999).

*HUD, *Guidelines for the Evaluation and Control of Lead-Based Paint Hazards in Housing* (June 1995).

*OSHA, *Interim Final Lead in Construction Standard*, 29 CFR 1926.62 (May 1993).

National Lead Information Center: 1-800-424-LEAD.



CHAPTER 4

IDENTIFYING LEAD-BASED PAINT HAZARDS

Learning objectives	4-3
Skit: Recognizing lead-based paint	4-4
Discussion questions	4-4
Lead dust	4-5
Where is lead-based paint?	4-6
Inspections	4-7
What surfaces need to be tested?	4-8
What a lead inspector does	4-9
Risk assessment	4-10
Tests for lead in paint, dust, and soil	4-12
Paint chip lab analysis	4-13
X-ray fluorescence (XRF) analysis	4-14
Dust wipe test	4-16
Anodic stripping voltametry	4-18
Wet chemical field tests	4-19
Soil sampling	4-20
Key facts for Chapter 4	4-21
For more information	4-22



Lead Abatement for Workers



Learning objectives

In this chapter you will learn about

- lead dust
- lead inspections
- when lead-based paint inspections are required
- risk assessments
- how inspectors and risk assessors test for lead-based paint and lead-based paint hazards using
 - paint chip analysis
 - X-ray fluorescence analysis
 - dust wipe tests
 - anodic stripping voltametry
 - wet chemical field tests
 - soil sampling



Skit: Recognizing lead-based paint

Spiker and Vinnie are getting ready to set up for a rehab job. Let's listen in on their conversation.

Spiker: Let's get the windows and doors out before we set up. It will save us some time, and we're already behind schedule.

Vinnie: Is that safe? How do you know there isn't any lead-based paint on them?

Spiker: The owner said replace all the windows and doors. You know, combine rehab with the lead abatement job.

Vinnie: Yeah, I know. But what if there's lead-based paint on them?

Spiker: Look, they were painted just last year. What are you worried about? If the windows had lead-based paint, don't you think the owner would know? Come on, stop trying to stall. Grab a tool and let's get started!

Vinnie: OK, you're the boss. Or at least you act like him.

Discussion questions

1. Is there a chance that the windows and doors would have lead-based paint on them? Why or why not?
2. Are lead-based paint and dust dangerous if they get on your clothes?
3. Can you tell if paint contains lead by looking at it?
4. What would you do if you were Vinnie?





Lead dust

Lead dust is poisonous when you breathe or swallow it.

Lead dust comes from lead-based paint. The dust is so small that you may not even see it. Lead dust is easy to breathe and swallow. Lead-based paint turns into lead dust when

- **it peels, chips, or flakes.**

This may occur when paint gets old, moisture-damaged, or damaged by weather changes.

- **surfaces covered with lead-based paint break or get disturbed.**

This happens during abatement, renovation, or demolition. When you saw or drill into a lead-painted surface, you create lead dust.

- **surfaces covered with lead-based paint rub against something.**

This is called **friction**. Windows and doors have friction surfaces. When you open a window, painted edges get rubbed together and create dust. When you walk on lead-painted floors, lead dust gets kicked up. The friction wears through the top layers of paint and exposes the older lead-based paint. When you sand or scrape lead-based paint, you create friction and lead dust.

- **surfaces covered with lead-based paint get hit with force.**

This is called **impact**. Impact surfaces include floors, stairs, parts of walls, and doors. When you bang a lead-painted wall with the back of a chair, lead dust is released. When you close a door, there is an impact. If the door is painted or hits surfaces painted with lead-based paint, lead dust can be released.

Whenever you create dust from a lead-painted surface, lead is released into the air.

Lead dust particles in the air can be inhaled into your lungs. When lead dust falls, it sticks to anything it lands on—floors and other surfaces, people, pets, and even food. If you get lead dust on your hands and put your fingers in your mouth, you will swallow lead particles.

Young children are most at risk for lead poisoning. They play on the floor. They put their hands and toys in their mouths. If lead dust is on the floor and toys, children are likely to get lead dust in their mouths and swallow lead particles. Sometimes children eat paint chips. Sometimes they chew on lead-painted surfaces, like window sills. Even if the lead-based paint is in good condition, a child may still chew the paint and swallow lead particles.

Lead dust is poisonous when you breathe or swallow it.

Lead dust comes from lead-based paint.



Test paint or assume it has lead.

Where is lead-based paint?

Any home built before 1978 may contain lead-based paint. Outside surfaces, kitchens, bathrooms, and windows are the areas most likely to have lead-based paint. However, lead-based paint can be found on any painted surface of a home. Sometimes the lead-based paint is buried under layers of latex paint.

You cannot tell if paint has lead in it by looking at it. Painted surfaces must be tested for lead content. Remember, only certified lead-based paint inspectors or risk assessors can conduct lead-based paint inspections! Your employer is required to find out if the paint you will be working on could expose you to dangerous levels of lead in the air. To be safe, make sure the paint has been tested *before* you disturb it. If the painted surfaces have not been tested for lead, assume they contain lead-based paint.

HUD Requirements

Public and Indian housing units, common areas, and exteriors of family housing must be inspected for lead-based paint if

- built before 1978 (must have been inspected by December 1994) and
- children younger than six years old live or may live there.

Most pre-1978 residential properties receiving HUD funds are subject to HUD requirements for lead-based paint (24 CFR 35). These regulations include requirements for notification, lead hazard evaluations, and lead hazard reduction. The lead hazard evaluation category includes the following activities

- visual assessment;
- paint testing;
- risk assessment.

Title X

As of December 1996, Title X requires that all known information about lead-based paint and lead-based paint hazards be provided at the time of sale or rental of any pre-1978 housing unit. It also allows home buyers ten days to arrange for a risk assessment to identify lead hazards or an inspection to identify the presence of lead-based paint.



Inspections

Checking for lead-based paint is called an **inspection**. Inspections must be done by a certified lead inspector or risk assessor. The inspector tests the paint with an X-ray fluorescence analyzer (XRF) to see if it contains lead. An inspector may also collect paint chip samples and send them to a lab for testing. Inspections are often done before a lead hazard control project begins so the owner and contractor know which surfaces are painted with lead-based paint. **Inspections identify the location of lead-based paint.**

States have different rules about how and when to test for lead-based paint. (Find out what your state laws say.) The Department of Housing and Urban Development (HUD) has developed final guidelines for lead-based paint-related activities, including inspections. The HUD *Guidelines* are applicable to inspections of any residential housing, including private, public, or Indian housing.

The 1992 Residential Lead-Based Paint Hazard Reduction Act (Title X) required EPA to develop regulations related to lead-based paint inspections in housing built before 1978. EPA issued training and certification regulations for inspectors, risk assessors, supervisors, project designers, and workers on August 29, 1996. These regulations went into effect in March 2000 in all states and Indian tribes that did not already have their own EPA-approved lead certification program established.

Inspections identify surfaces containing lead-based paint.



Any painted surface can have lead-based paint.

What surfaces need to be tested?

The HUD *Guidelines* recommend testing **all types of painted, stained, shellacked, and varnished surfaces.** (Your state may require testing all painted surfaces or just some.)

Anything painted is a painted surface. Any painted, stained, shellacked, or varnished surface may contain lead. Painted, stained, shellacked, or varnished surfaces are found both inside and outside the home. They include, but are not limited to,

- ceilings
- doors
- floors
- molding
- radiators
- cabinets
- shelves
- staircases
- walls
- windows
- porches
- baseboards
- siding and trim
- gutters
- roofs
- sheds
- interior trim
- and more



What a lead inspector does

Lead inspectors must have special training and certification. To start an inspection, the lead inspector will find out when the home was built and get or make a sketch of the home. The inspector will number the rooms to be tested and label the sides of the house starting with the street or address side as "A." The windows and doors can be numbered and labeled according to the side of the house on which it is located (e.g., C1, C2). (See Figure 4-1.) Inspectors will test any surface that is painted or varnished to find out if any lead is on that surface and how much lead is present.

The inspector records the following information about each sample:

- what room the sample or reading was taken in;
- which part of the room the sample or reading was taken from (i.e., left window apron);
- where on the painted surface the reading or sample was taken (i.e., upper middle sash or lower left door frame).

An inspector or risk assessor also does clearance inspections at the end of an abatement project or some federally-assisted rehabilitation/renovation projects. For these clearance inspections, the inspector will take dust and soil samples (optional) to find out if the cleanup was done carefully. The inspector will identify each type of sample (i.e., dust wipes, soil samples) on specific data forms. XRF readings are also listed on specific data forms.

Lead inspectors must have special training.

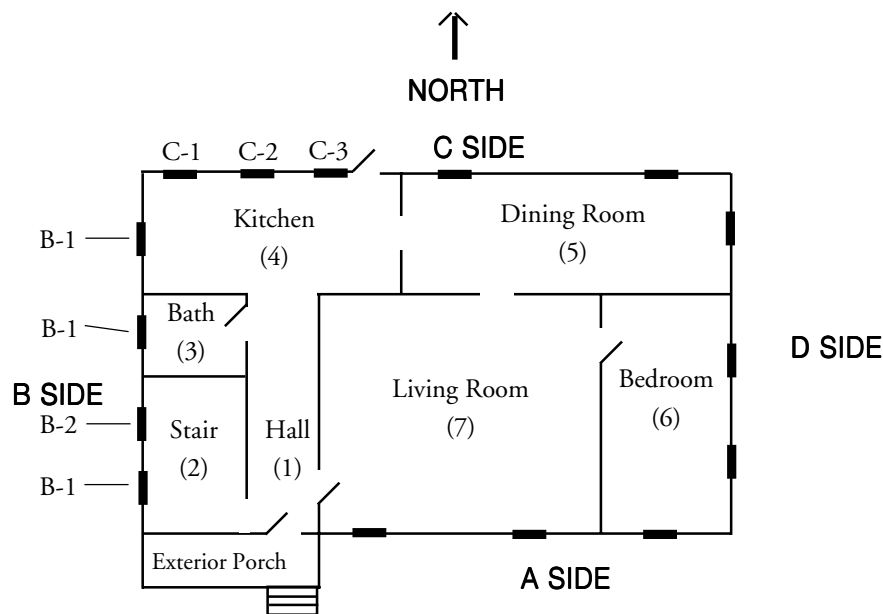

Figure 4-1. Example inspector's sketch of a home.



Risk assessments look at:

- lead hazards;
- who lives in the home;
- how to control hazards.

Lead dust is a health hazard.

Deteriorating lead-based paint causes lead dust.

Friction and impact cause lead dust.

Risk assessment

An inspection tells you where the lead-based paint is in a home. A risk assessment tells you if the lead-based paint could be a health hazard to the people who live in the home. A risk assessment looks at

- lead-based paint hazards;
- the people who live in the home;
- how these hazards can be controlled.

The person who does a risk assessment is called a risk assessor. A risk assessor has to get special training and certification.

Lead hazards

The risk assessor first looks at the places where lead-based paint is in the home. This is the information that the inspector collected. If no inspection has been done, the risk assessor looks at the condition of the home and of the paint. Then the risk assessor figures out which surfaces might be creating lead hazards.

Any exposure to lead from contaminated dust, soil, or paint that could make you ill is a lead-based paint hazard. Lead is a hazard when you breathe or swallow it. Dust from lead-based paint is a major hazard. Risk assessors look for sources of lead dust in the home, such as

Deteriorating lead-based paint—Painted surfaces deteriorate for a number of reasons. The primary reason is moisture. Rain, leaks, condensation, and spills can cause paint to break down. Sun, heat, cold, and wind can wear down paint on exterior surfaces. Paint will also deteriorate if it is not put on properly. Putting paint on glossy or greasy surfaces or on rotting or termite-damaged wood is not proper application. Sometimes the new layer of paint is incompatible with the old paint layer. This can also cause deterioration.

Friction surfaces—Paint dust also forms any place where a painted surface rubs against another surface. When two surfaces rub against each other, the movement causes **friction**. Friction causes paint to flake, chip, and form dust. Lead-painted windows are the places where friction most often causes lead dust. Whenever a window goes up or down, it causes friction.

Impact surfaces—Paint can be weakened by impact or forceful contact. This happens when doors and windows close. Doors and windows have many impact points where paint can flake and chip.

Lead dust buildup—Lead dust is made of tiny lead particles. Lead particles are heavy and they stick to surfaces. They land close to the surface they came from. When a lead-painted wall is flaking and peeling, the lead dust particles fall close to the wall. Lead dust tends to build up in spaces close to friction surfaces, such as window troughs.

Identifying Lead-based Paint Hazards



Lead dust can also build up in areas that are not cleaned properly. Lead dust gathers in cracks. It builds up behind cabinets, between floor boards, and behind baseboards. The dust may come out of the cracks over time due to air movement, impact, pressure, or even a child picking at the floor.

People who live in houses with lead-based paint

Besides looking at possible lead-based paint hazards, the risk assessor looks at the people who live in the home. These are the people who may get lead poisoning. If there is a lot of lead dust, the risk increases that someone will get lead poisoning.

Children and pregnant women are at highest risk for lead poisoning. A home with deteriorating lead-based paint where a young child and a pregnant woman live would be a very high-risk home.

Lead hazard controls

After the risk assessor has identified the lead-based paint hazards, he or she will put together a plan to control the lead-based paint hazards. Then a contractor and his or her workers implement the hazard control plan.

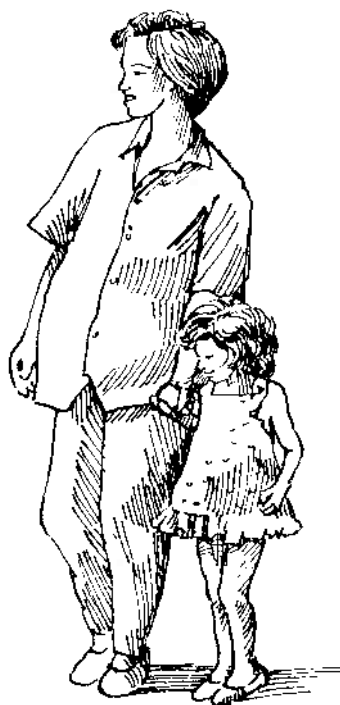

Children and pregnant women are at highest risk for lead poisoning.



Tests for lead in paint, dust, and soil

An inspector can use a number of methods to test for lead in different sources such as paint, dust, or soil. Each test has advantages and disadvantages. The results are all measured differently. We'll take a look at the following tests in this chapter:

- paint chip lab analysis
- X-ray fluorescence (XRF) analysis
- dust wipe test
- anodic stripping voltametry
- wet chemical field tests
- soil sampling



Paint chip lab analysis

The inspector takes paint samples from painted surfaces and sends them to a lab for lead tests. The test, called paint chip lab analysis, shows how much lead is in the paint. The inspector should wear safety goggles or glasses and gloves when taking samples. Gloves must be changed after each sample is collected.

Advantages

Paint chip analysis can be very accurate when the inspector correctly collects the sample. The paint chip sample must include **all the paint layers** of the tested surface but no wood, plaster, or other material underneath the paint. (This is not always easy to do.)

Disadvantages

Paint chip analysis costs \$5 to \$20 per sample. It takes two days to two weeks to get the results, sometimes longer. To get a sample, the inspector has to disturb the painted surface. Patches of paint in the area scraped (for the sample) may get left behind. The inspector or owner will have the added expense of repairing and repainting the surface.

Results

Paint chip analysis most often measures the amount of lead in the paint by weight. The weight of lead in the sample is compared to the weight of the entire sample. The lead in the sample is reported as a percentage by weight. If the sample is 0.5 percent lead or higher, HUD says that the surface tested should be considered a lead-based paint surface. Lead in paint chips can also be measured in milligrams per square centimeter (mg/cm^2), but only if the exact area of the paint chip is measured. The 1995 HUD *Guidelines* recommend getting paint-chip results reported in mg/cm^2 if at all possible.

Samples must be clearly labeled.

Paint chip samples must include all paint layers.

Sometimes paint chip lab analysis is used to back up XRF tests.



XRFs can be used on site.

X-ray fluorescence (XRF) analysis

The inspector can also use a machine called an **X-ray fluorescence analyzer**, or **XRF**. An XRF works similar to an X-ray machine at the doctor's office, but the process is different. Radioactive waves are used to find the lead in paint. But, instead of taking a picture, the XRF tells us how much lead is in the paint. This test is called XRF analysis. XRF machines must be used very carefully because they produce radiation. Inspectors need special training to prevent radiation exposure.

Advantages

The XRF machine is portable and can be used on site. For most painted surfaces, it can determine whether or not lead-based paint is present. Usually, it does not damage the painted surface as paint chip sampling does.

Disadvantages

XRFs cost from \$8,000 to \$20,000. XRF inspectors must have radiation safety training. They also need special training to operate the machine. After this training, they must get a permit to use an XRF machine. Permits, training, and replacement parts can also be expensive—about \$3,000 to 4,000 per year.

Many things can interfere with XRF readings and result in inaccurate results. Brick, metal, and other building materials that the lead-based paint is on can affect the XRF readings. Temperature, humidity, radio waves, and vibration can also cause false readings. Some surfaces—like corners and narrow edges—cannot be measured by an XRF.

Results

XRF readings tell how much lead is in the tested surface area. Results are reported in milligrams (mg) per square centimeter (cm²). A milligram is one-thousandth of a gram. A square centimeter is about the size of your thumbnail.

In single-family housing XRF readings will be taken of each painted or stained surface type (e.g., baseboard, floor, door) present in each room. In multifamily housing (large developments with a lot of apartments or units) an inspector doesn't have to inspect every unit. The number of units that must be inspected depends upon the year the housing was built *and* how many total units or apartments there are in the development. If the XRF readings are equal to or greater than 1.0 mg/cm², those surfaces are coated with lead-based paint. Some states or localities have rules or regulations that set a lower (or higher) level of lead in paint for it to be called lead-based paint. If a state or local rule or regulation sets a different level of lead in paint, the more stringent (i.e., lower) regulation should be used. Check your state, tribal, and local laws.



Laboratory testing method

Sometimes, an inspector will take a paint chip test sample from the same surface area to confirm the XRF readings. The paint chip lab results will be compared with the XRF results. Paint chip analysis performed by an accredited laboratory is more accurate than XRF testing.



Dust wipe tests tell you if there is lead dust.

Dust wipe test

Dust wipe tests measure lead dust on surfaces. High levels of surface lead dust are an immediate danger. Dust tests do not determine the presence of lead-based paint that is several layers down. They show whether there is lead in the dust.

The inspector or risk assessor collects dust from surfaces with commercial wipes. Inspectors must wear disposable gloves when collecting samples. Most dust wipes are taken during a clearance inspection or a risk assessment (see page 4-20). Inspectors can take single dust wipe samples from one surface and have it analyzed, or they can wipe several of the same surfaces (e.g., floors) and have them analyzed together. The latter is called composite sampling. When doing composite sampling, inspectors do not have to change gloves between dust wipes until they are going to wipe a different surface (e.g., the inspector takes dust wipe samples from several floors in a dwelling and then changes gloves and takes several dust wipe samples from window sills). The dust wipe samples are sent to an accredited laboratory to find out how much lead dust each sample contains.

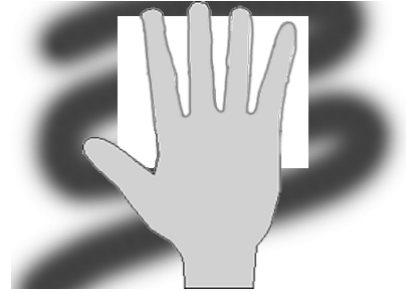

Advantages

The dust wipe test is easy to do and costs about \$5 to \$20 per test. The results tell you whether lead is in the dust. It gives you a good indication if there is a lead dust hazard on the surface wiped.

Disadvantages

The dust wipe test cannot tell you exactly how much lead is in the paint. It cannot tell you which surfaces will need to be abated. It can tell you only **if lead dust is present** and give you **an idea of how much**. Lead dust may be coming from sources other than lead-based paint.

Results

Results are measured in micrograms of lead per square foot ($\mu\text{g}/\text{ft}^2$). A microgram is one-millionth of a gram.

Dust wipe tests are taken at two times. First, they are used to test homes to see if dust-lead hazards exist. These dust tests are crucial in preventing lead poisoning.

Some homes cannot be abated right away. While the family waits, they can do things to reduce the amount of lead dust. These actions are called “interim controls.” When lead dust is reduced, the source of lead poisoning is reduced. (For more information on interim controls, see Chapter 5.) Dust wipe tests can show if interim controls are helping.



Identifying Lead-based Paint Hazards

Second, dust wipe tests are used at the end of an abatement project or some federally-assisted rehabilitation/renovation projects. The dust samples show whether the cleanup of these jobs was done well enough. They tell you if the house is ready for the occupants to return.

EPA has established levels of lead in dust that should be considered a hazard. These levels only apply to dust wipe samples collected on floors and window sills. The average of the dust test results for each type of surface must be below the levels presented in Chapter 3. If the dust levels are equal to or higher than this, there is a dust-level hazard. For clearance, all samples must be below the clearance standards. If any sample is equal to or higher than the clearance standards, then the type of surface represented by that sample must be recleaned. For example, if a window sill sample fails clearance, the workers only have to reclean the sills.

The Baltimore City Department of Health used a wipe sampling to do a study of 20 houses that were abated of lead-based paint. The average results are below.

During the abatement, work practices were carefully monitored. The use of heat guns and dry scraping was not allowed. After abatement, wet cleaning and HEPA vacuums were used to thoroughly clean the houses.

DUST LEVELS BEFORE AND AFTER ABATEMENT			
Surface	Before Abatement	After Chemical Stripping*	After Replacement, Encapsulation, and Enclosures*
Floors	1,300 $\mu\text{g}/\text{ft}^2$	59 $\mu\text{g}/\text{ft}^2$	44 $\mu\text{g}/\text{ft}^2$
Window sills	7,634 $\mu\text{g}/\text{ft}^2$	125 $\mu\text{g}/\text{ft}^2$	17 $\mu\text{g}/\text{ft}^2$
Window troughs	59,202 $\mu\text{g}/\text{ft}^2$	252 $\mu\text{g}/\text{ft}^2$	49 $\mu\text{g}/\text{ft}^2$

* The clearance dust levels for floors, sills, and troughs were higher when this study was conducted than the levels in effect today.



**ASV allows
sample analysis
at the job site.**

Anodic stripping voltametry

Anodic stripping voltametry (ASV) is another analytical method for identifying small amounts of metals within paint chip, soil, dust, or water samples. The ASV equipment is small and portable so that analysis can be at the job site. Depending on where the job site is located, ASV may provide quicker results from sample analysis than if the samples had to be sent off to a laboratory.

Advantages

The ASV allows samples to be analyzed at the job site. It is relatively easy to use and provides a quicker turnaround time for results than laboratory analysis.

Disadvantages

ASV requires training in chemical handling. The per sample price is about the same as for a fixed-site laboratory analysis. The equipment requires a source of electricity. Firms using the equipment need to be accredited as a laboratory.



Wet chemical field tests

Some inspectors use wet chemical field tests (spot tests) to find out if paint contains lead. The sodium sulfide test and the sodium rhodizonate test are two examples. EPA, CPSC (the agency that established the legal limit of lead in paint), and HUD currently do not recommend chemical field tests, because research has not proven their effectiveness.

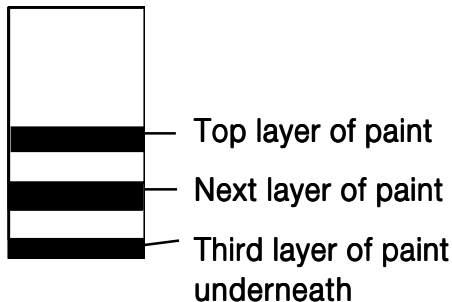

Wet chemical field tests may not be reliable.

The chemical test solutions are clear (sodium sulfide) or yellow (sodium rhodizonate) liquids. To do the test, the inspector scrapes the painted surface down to the wall surface or substrate. All the layers of paint must be exposed. Then the inspector puts a drop of test solution on the painted surface.

Results

If lead is in the paint, sodium sulfide turns gray, brown, or even black. Sodium rhodizonate turns pink or red when lead is present.

Advantages

This is a quick, easy test to do. It is done on site. It is inexpensive.

Disadvantages

- Sodium sulfide works well only with white paint. Colored paints are hard to read.
- The changes in color can be missed.
- Other metals can cause the same color change that lead does.
- These tests do not tell how much lead is in the paint.
- These tests only test exposed layers of paint. These tests will not tell you if coats of paint that are not exposed have lead in them.
- Sometimes these tests say lead is present when it is not.
- Dirt or plaster can hide a color change.
- EPA, CPSC, and HUD currently *do not* recommend chemical field tests, because research has not proven their effectiveness.



Soil can contain hazardous amounts of lead.

Soil sampling

Soil can have high levels of lead. You usually find the highest levels of lead in soil close to the surface (top 2.5 cm or 1 inch). Lead in soil can be a major hazard. Children play outside in the soil. They can get lead-containing dust or dirt on their hands, clothes, and toys. Children can get lead poisoned by playing in soil that contains lead.

Soil sampling and analysis tells how much lead is in the soil. Soil samples are most often collected as part of a lead risk assessment. The risk assessor doing the test needs special training. He or she will dig into the soil with a special tool called a **coring tool**. The coring tool takes samples from the top 1/2 inch of soil. An inspector may also use a disposable syringe, spoon, or other tool to scoop up the soil. Soil on all sides of the building should be tested. Play areas with bare soil will also be sampled.

The test results compare the amount of lead to the amount of soil in the sample. Results are reported in parts per million, or ppm. High levels of lead are usually found close to a house with lead-based paint on the exterior. High levels of lead are often found in the soil close to the street. Lead in the soil close to the street often comes from leaded gasoline.

EPA has established hazardous levels of lead in soil. A soil-lead hazard is present if the level of lead in bare residential soil is at or above 400 parts per million in a play area or an average of 1,200 ppm or higher lead in other bare areas of a yard.

Neither EPA nor HUD require soil sampling after abatement or rehab work. However, inspectors may test for lead in soil when lead-related work was done on the outside of a house or building or if lead-painted debris was stored on the property. These tests may be part of a clearance inspection.

Lead soil levels are sometimes highest close to the house and the street.

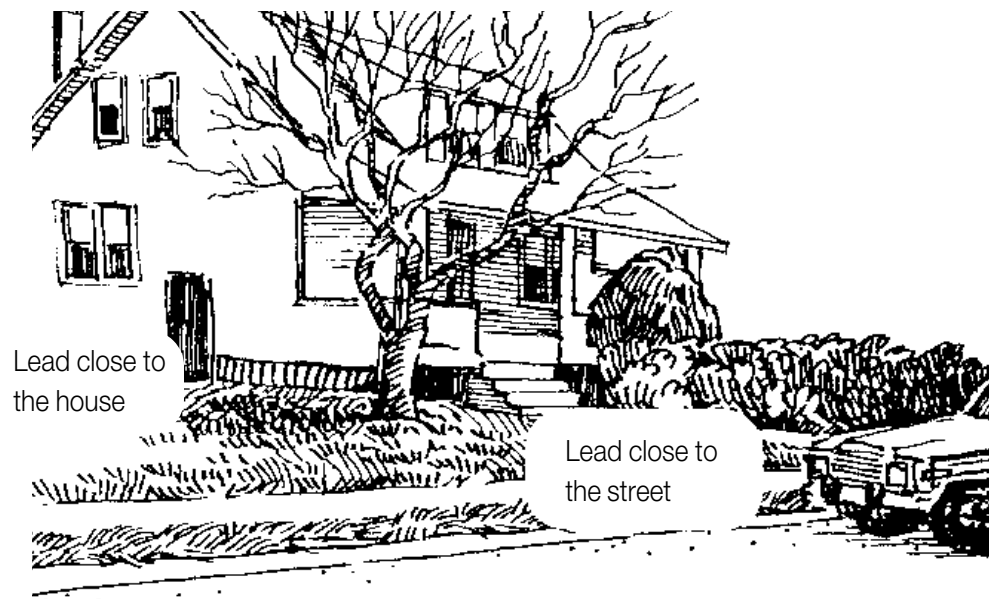



Key facts for Chapter 4

 A lead-based paint hazard is any exposure to lead from contaminated dust, soil, or paint that makes you sick.

 Lead dust is a hazard when you breathe or swallow it.

Any painted surface can have lead-based paint.

HUD *Guidelines* recommend testing all painted surfaces.

Test paint or assume it has lead.

 Inspections show which paint has lead.

Lead-based paint inspectors must have special training and certification.

 Risk assessments look at whether a home contains lead hazards.

Lead risk assessors must have special training and certification.

Lead-based paint dust is a health hazard.

Sources of lead-based paint dust include

- deteriorating lead-based paint
- friction on a lead-based painted surface
- impact on a lead-based painted surface
- places where lead dust builds up

Children and pregnant women are at highest risk for lead poisoning.

 Testing for lead in paint and lead hazards

XRFs are used on site.

Paint chip analysis is used on its own and to back up XRF tests.

Paint chip samples must include all paint layers.

Dust wipe tests tell you where there are lead dust hazards.

Dust wipe tests are also done after every abatement job as the final clearance test for the job. The test results show if the post-abatement cleanup was adequate.

Soil tests tell you how much lead is in the soil and if soil-lead hazards exist. Soil may also be tested for lead after lead work is done on the outside of a home or building.



For more information

These publications have more information on the topics covered in this chapter. Your instructor has a copy of the publications marked with a star (*). You can order your own copy by calling 1-800-424-LEAD.

Alliance to End Childhood Lead Poisoning, *Guide to State Lead Screening Laws* (October 1991).

Alliance to End Childhood Lead Poisoning, *Resource Guide for Financing Lead-Based Paint Cleanup* (October 1991).

Environmental Defense Fund, *At a Crossroads: State and Local Lead Poisoning Prevention Programs in Transition*.

* EPA, *Lead: Identification of Dangerous Levels of Lead; Final Rule*; 40 CFR Part 745 (January 2001)

* EPA, *Reducing Lead Hazards When Remodeling Your Home* (September 1997).

* EPA, HUD, and CPSC, *Protect Your Family From Lead in Your Home* (June 2003).

* HUD, *Guidelines for the Evaluation and Control of Lead-Based Paint Hazards in Housing* (June 1995).

* National Lead Information Center, *Testing Your Home for Lead*, Fact Sheet (1993).

National Lead Information Center Hotline: 1-800-424-LEAD.



CHAPTER 5

CONTROLLING LEAD-BASED PAINT HAZARDS

Learning objectives	5-3
Skit: What do you need to know about lead?	5-4
Discussion questions	5-4
Reducing lead-based paint hazards	5-5
When does lead-based paint become a hazard?	5-5
Where is lead-based paint found?	5-7
Who will reduce the lead hazards?	5-8
How will lead hazards be reduced?	5-9
Title X's two-step plan for reducing lead hazards	5-10
Abatement	5-11
Interim controls	5-12
Education programs	5-12
Special cleaning methods.....	5-12
Repairs, repainting, and maintenance	5-13
An interim control plan for a house	5-14
In-place management	5-15
Holistic approach to lead-hazard control	5-16
Special cleaning methods	5-17
HEPA vacuum	5-18
How to use a HEPA vacuum	5-19
Wet cleaning	5-22
Key facts for Chapter 5	5-25
For more information	5-27





Learning objectives

In this chapter you will learn about

- Title X
- six situations where lead is a hazard
- who will reduce lead hazards
- lead-paint abatement
- interim controls
- special cleaning
- how to use interim controls for a home
- operations and maintenance programs
- the parts of a HEPA vacuum
- how to use a HEPA vacuum
- how to use the four-step system



Skit: What do you need to know about lead?

Sandy and Tim are maintenance workers at a local elementary school. The school was built in 1960 and needs repair. Since summer is coming and school will be out, Sandy and Tim are told to take care of the lead-based paint in the building. The school district can not afford complete abatement.

Sandy: I'm a little concerned about this lead-based paint. That's all you read about in the papers.

Tim: Well, it should not be such a big problem. I hear the main thing to deal with is the windows.

Sandy: I don't know. I wish I knew more about it.

Tim: Don't make such a big deal. Look, we'll scrape the peeling paint, vacuum everywhere and then paint over it. That should take care of it.

Sandy: I'm not sure.

Discussion questions

1. Do Sandy and Tim seem to know enough about lead-based paint to take on the job?
2. What should Sandy and Tim do before they begin any work?
3. What surfaces should be a high priority for Sandy and Tim?
4. What type of interim controls can they use on these surfaces?
5. What items are essential to a good Operations and Maintenance program?





Reducing lead-based paint hazards

Children most often get poisoned by lead because they swallow lead dust. In the early 1990s the Congress of the United States found that

- more than 3 million children were estimated to be affected by low-level lead exposure;
- the most common cause of lead poisoning in children is swallowing lead in household dust;
- there were more than 3 million tons of lead in lead-based paint in the total number of houses built before 1980.

In October 1992, Congress passed a law called the Housing and Community Development Act. This Act includes Title X of the Residential Lead Based Paint Hazard Reduction Act of 1992 (Public Law 102-550). The purpose of this act is to reduce lead-based paint hazards.

Since the passage of Title X, EPA, HUD, and OSHA, have implemented several regulations aimed at reducing worker's and the public's exposure to lead-based paint hazards. The number of homes with lead-based paint and lead-based paint hazards has been reduced. Additionally, CDC estimates the number of children with too much lead in their blood has also been reduced (from more than three million to just over 400,000). While these reductions are impressive, there is still a lot of work to be done to reduce lead-based paint hazards in housing and lead poisoning of children and workers. You play an important role in that effort!

When does lead-based paint become a hazard?

EPA has defined the conditions under which lead-based paint in a dwelling or child-occupied facility becomes a hazard:

- **lead-based paint on any friction surface that rubs against another surface and creates a lead-dust hazard**

A friction surface is any surface that rubs against another surface. Windows and floors are friction surfaces.

- **lead-based paint that is damaged or deteriorated on any impact surface**

An impact surface is any surface that receives forceful contact over and over again. Windows and doors have impact surfaces; floors and stairways are impact surfaces.

- **any chewable lead-painted surface on which there is evidence of teeth marks**

The child chews on the surface and swallows the lead particles. These surfaces are also called accessible surfaces. An interior window sill is an example of a chewable surface.

As a lead abatement worker, you play an important role in reducing lead-based paint hazards in housing.



- **damaged lead-based paint**

All building materials get damaged and deteriorate. All building materials with lead-based paint can create lead dust.

- **dust-lead hazard**

Dust anywhere in the home that is at or above the standards for floors and window sills that have been established by EPA. There are two sets of dust standards—*dust-lead hazards* and *clearance lead-dust levels*. The clearance levels must be met after abatement or federally-assisted rehabilitation/renovation activities have been performed (these levels were discussed in Chapters 3 and 4).

- **soil-lead hazard**

Lead-contaminated soil is bare soil with lead at or above the levels set by EPA (these levels were discussed in Chapters 3 and 4).

A lead-based paint hazard is possible wherever lead dust can be created. When lead dust is created, you can breathe or swallow it. It is a hazard to your health.

Your supervisor or employer is required to make sure the project is in compliance with the applicable standards.



Where is lead-based paint found?

Lead-based paint may be found in buildings built before 1978. That includes our homes, schools, community centers, libraries, hospitals, and other public and commercial buildings built before 1978. Today, it can still be used on bridges and steel structures. Lead-based paint is almost always found on bridges and steel structures because it prevents corrosion. Any time there is bridge repair, lead dust is likely to be created. Any time an older house is renovated there is a potential lead hazard. Any time demolition is done on an older building, there is a potential lead hazard.

Lead-based paint may be found in any building built before 1978.



Many different people will work to reduce lead hazards.

Who will reduce the lead hazards?

Reducing the lead-based paint hazards in the United States is a huge job. It will take many years and a lot of resources. Many different people will work to help reduce the lead hazards:

- **Certified small contractors** will abate homes using trained certified workers.
- **Certified large contractors** with trained certified workers will abate large building complexes, facilities, and steel structures.
- **Community organizations and tenant associations** will have members trained to reduce lead hazards in the homes, playgrounds, and community facilities.
- **Public employees** of schools, housing, and state and municipal agencies will be trained to provide lead-safe facility maintenance and custodial care.
- **Homeowners** who get training often work in their own homes.
- **Contractors, supervisors, and workers** should also be licensed to conduct lead-related jobs.
- **Trained renovation, rehabilitation, and maintenance workers** using lead-safe work practices.



How will lead hazards be reduced?

Title X gives a detailed plan to reduce lead hazards. Here are some of the important parts of Title X's plan:

- EPA, OSHA, and HUD are working together and have developed standards, regulations, and funding to reduce lead hazards.
- The federal government is educating the public about lead hazards.
- If a property seller or landlord knows about lead hazards on the property, he or she must inform potential buyers or renters about them.
- Home buyers have the right to get a lead inspection or risk assessment of that home.
- There are state, tribal, and federal rules which require training and certification/ licensing for lead abatement contractors and workers.
- There are minimum work practices which must be followed when doing lead-based paint abatement.
- There are specific work practices which are prohibited when working on lead-based paint in housing or child-occupied facilities.
- Renovators and remodelers must give out a lead information pamphlet to consumers before renovation or remodeling begins.



Title X has a two-step plan:

- **evaluate for lead hazards;**
- **reduce lead hazards.**

Title X's two-step plan for reducing lead hazards

- **Evaluate the lead hazards.**

Evaluating lead hazards will help answer very important questions:

- Which homes need to be taken care of first?
- Who in the home might get poisoned?
- What actions will reduce lead hazards?

The information gathered in the inspections and risk assessments (Chapter 4) will help answer these questions.

- **Reduce the lead hazards.**

Once the lead hazards are identified they need to be reduced. Reducing lead hazards means getting rid of the lead that is dangerous to an individual's health. Title X states two ways of reducing lead hazards. They are called **abatement** and **interim controls**.



Abatement

Lead-based paint abatement is a set of actions that permanently eliminate lead-based paint hazards. HUD has defined “permanent” as lasting at least 20 years. Some of these actions are permanent as long as the protective material stays intact. These actions are sometimes called abatement strategies. Abatement includes, but is not limited to:

- replacement
- removal
- enclosure
- encapsulation; and
- the removal or permanent covering of soil.

EPA's definition of abatement also includes all preparation, cleanup, disposal, and post-abatement clearance testing activities associated with these measures.

Enclosure and encapsulation of lead-based paint are included as abatement methods. However, enclosure and encapsulation do not remove the lead-based paint; they abate the lead-based paint hazard by covering it.

Lead abatement must be done with special work practices, skill, and care. This training provides you with the basic information you need to know for lead abatement. You will read more about abatement actions in Chapters 7, 8, 9 and Appendix A of this manual.



Interim controls only remove the lead hazard temporarily.

Interim controls keep the lead dust levels down.

Community members, building occupants, and workers need to know about lead hazards.

You must use special cleaning methods.

Interim controls

Interim controls are actions that reduce the lead hazard temporarily. They are a temporary solution. They can be very helpful. They keep the lead dust levels down and can prevent lead poisoning. Areas where interim controls are being used need to be regularly inspected to make sure the controls are still working. HUD has developed a schedule for monitoring each interim control activity. Interim controls include the following:

- education programs
- special cleaning
- repairs, repainting, and maintenance.

Education programs

Anyone who uses interim controls should have special training. You create lead dust when you use interim controls. You will move lead dust around. This creates a hazard. You need to know how to work safely with lead. This course is an example of such training.



Other education programs would be lead hazard awareness training for building occupants and workers who will not be doing lead work. Both groups need to be aware of lead hazards. They need to know where the lead-based paint surfaces are and what is being done to control them.

Special cleaning methods

Special cleaning can be used by itself to control lead dust. Special cleaning **must** be used with all abatement methods. Research shows that there are two cleaning methods that work well to reduce lead dust:

- HEPA vacuuming
- washing with an all-purpose cleaner or a cleaner made just for lead cleanup

These cleaning methods work best when they are used together, one right after the other. You will learn more about special cleaning methods later in this chapter.



Repairs, repainting, and maintenance

The purpose of interim controls is to reduce the lead hazard until the hazard can be abated. Repairing lead-painted surfaces and repainting them with a non-lead-based paint combine to reduce lead dust until those surfaces can be abated. You must monitor and maintain any surface that you repair or repaint. Many actions are included in the repair and maintenance of lead-painted surfaces.

A small repair job at home

A heavy mirror was hung on the wall of your bathroom. The weight of the mirror caused the hook and nail to pull out of the wall. The mirror fell onto the sink. Fortunately, it did not break. The wall now has a hole as wide as a penny and an inch deep where the nail use to be. The paint around the hole is chipped.

This small and simple repair could include

- wet washing the paint dust and chips
- wet scraping the chipped paint
- repairing the hole with caulk or putty
- repainting the surface
- wrapping and disposing of debris

Monitor any surface you repair or repaint.

Make sure the surface remains in good condition.



Make sure the interim controls you use are legal in your city and state.

Look in Appendix A for step-by-step instructions on interim controls and abatement in housing.

An interim control plan for a house

Here is a set of actions that can be used as interim controls for a home. Combined, these actions can reduce lead exposure. Make sure interim controls are allowed by state and city laws before using them.

Before you begin, make sure you contain the area. Set up signs and barrier tape to keep nonworkers out of the area. Wear appropriate protective gear until you are ready to repaint.

- **Do a special cleaning.**

Vacuum the whole house with a HEPA vacuum. Then use an all-purpose cleaner or a cleaner made just for lead cleanup to wash the entire house. Pay special attention to the areas that are not frequently cleaned (e.g., window troughs, above doors and windows, etc.).

- **Do small repairs to the windows to reduce lead dust.**

Cut a piece of sheet metal or plastic the same size as the window trough. Back caulk the piece and nail it in place. This repair will enclose the trough and create a cleanable surface. It will reduce the lead dust the paint on the window creates and make the window easier to clean later on.

- **Wet scrape edges and loose paint.**

Wet scrape the leading edge of the interior window sill. Wet scrape any other loose, peeling paint.

- **Wash the entire house with the cleaning solution again. Then HEPA vacuum the entire house again.**

- **Have an inspector or risk assessor do clearance dust wipe tests.**

- **Repaint the wet-scraped surfaces with non-lead-based paint.**

These actions will reduce the amount of lead dust in the home and make it a safer environment for both children and adults. The home will still need to be monitored for lead hazards on a regular basis. Step-by-step instructions for doing interim controls and abatement in housing are located in Appendix A at the end of this manual.



In-place management

In-place management is necessary whenever you use interim controls. Keeping a lead-based paint surface in good condition prevents damage and dust. Controlling lead dust and paint chips during routine cleanup and maintenance activity also helps reduce lead hazards.

Custodians and maintenance personnel clean and repair schools, hospitals, and other public and commercial buildings. Any facility that has lead-painted surfaces should have an in-place management program.

A good in-place management program can help prevent lead poisoning. It can help make and keep a building lead safe. A good program should include at a minimum the following:

- an education program for workers and building occupants to make them aware of lead-based paint hazards, where the lead-painted surfaces are located, and what actions are being taken to make the building lead-safe;
- safe work practices training for the custodians and maintenance workers;
- a written program for each building that identifies all sources of lead exposure;
- a lead program manager who is in charge of all activities related to lead and who communicates with workers, outside contractors, and occupants regularly;
- ongoing monitoring and checking of the condition of lead-painted surfaces;
- records of all inspections, work activities, maintenance, ongoing monitoring, worker medical exams, exposure monitoring, waste disposal, and other activities.

EPA and HUD have developed courses on how to reduce lead-based paint hazards during maintenance and renovation or remodeling. These courses presents the steps maintenance or renovation workers can take to minimize lead dust generation and soil contamination during activities which affect lead-based painted surfaces.

Everyone in the building is involved in preventing lead hazards when an in-place management program is working.

A good in-place management program can help prevent lead poisoning.



Holistic approach to lead-hazard control

The goal of planning and doing lead-hazard control is to create a safe environment at an affordable price.

Lead work should always be a part of a maintenance approach. Maintenance work should always be done as part of lead in-place management or abatement work. Lead-based paint work should never be done without looking at long-term maintenance issues. Consider the following issues:

- It makes no sense to replace windows if the replacement does not benefit energy conservation. Energy-efficient replacement windows will increase the value and efficiency of the building.
- Moisture problems can cause lead-based paint failure and may result in termite damage or structural problems. Repair all sources of moisture before or during abatement.
- Carpets can store lead dust as well as bacteria and mold that cause respiratory disease. Bacteria, mold, and lead dust are almost impossible to clean out of carpets. Whenever possible, carpets should be removed and replaced. If that is not possible, the best cleaning methods include steam cleaning (with beater bar attachment) off-site or dry cleaning area rugs.



Special cleaning methods

Special cleaning can be used by itself to control lead dust. Special cleaning **must** be used with all abatement methods.

Research shows that HEPA vacuuming and washing with an all-purpose cleaner or a cleaner made just for lead cleanup are the methods that work well to reduce lead dust. They work best when used together, one right after the other:

- HEPA vacuum all surfaces.
- Wash all surfaces with an all-purpose cleaner or a cleaner made just for lead cleanup.
- HEPA vacuum all surfaces again.

For best results:

- 1. HEPA vacuum;**
- 2. Wet wash;**
- 3. HEPA vacuum again.**



HEPA vacuum

Always use a HEPA vacuum on a lead job. A HEPA vacuum is an industrial strength vacuum cleaner with a HEPA filter. HEPA stands for “High Efficiency Particulate Air.” HEPA filters can catch lead dust. A regular shop vacuum will not filter out the lead dust. A shop vacuum just blows the lead back out into the room.

Always use a HEPA vacuum on lead jobs.

True story:

What can happen if you don't use a HEPA-vacuum

Mr. B. and his wife stripped all the lead-based paint from their home in New York. The family lived in two rooms of the house while work was done on the rest of the home.

Mr. B. wanted to protect his infant daughter, Mary, from lead. He vacuumed the entire house every day. He used a regular vacuum. The regular vacuum blew the lead dust back into the area where his family was living every time he vacuumed. As a result, Mary's blood lead level went up to 37 µg/dL. She had to receive chelation therapy. Two years later her blood lead level returned to normal.

Blakelee, S. “Lead-Calcium Time Bomb.” American Health. November 1990.



How to use a HEPA vacuum

1. Lightly mist area with water to keep dust levels down.

Some HEPA vacuums can combine a wet wash with the vacuum. Read the manufacturer's instructions on how to use it.

2. Move slowly.

Remember, lead dust sticks to surfaces. Vacuum slowly so the HEPA vacuum can pick up all the lead dust.

How a HEPA vacuum works

Most HEPA vacuums have three filters: a pre-filter, a secondary filter, and a HEPA filter.

1. Debris gets sucked in through the hose into the vacuum bag.
2. The air and dust get filtered through the pre-filter, the secondary filter, and the HEPA filter.
3. The HEPA filter captures the lead dust before the air is released into the work area again.

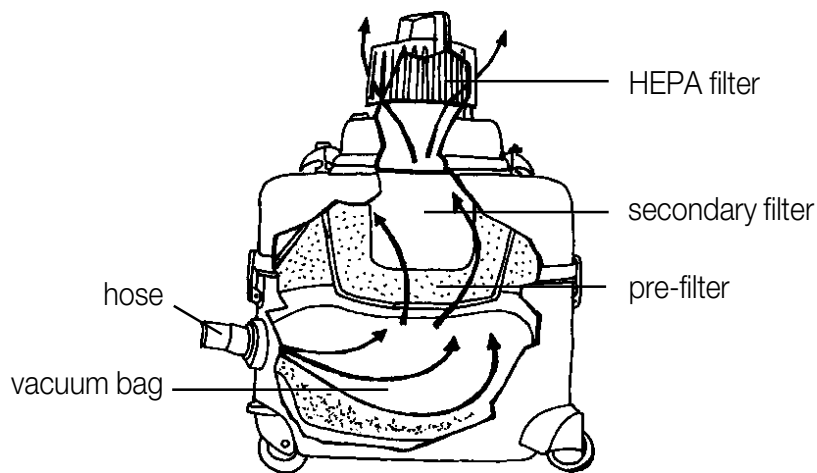

Most HEPA vacuums have three filters.



HEPA vacuum every surface.

3. HEPA vacuum all surfaces.

Start at the end farthest from the main entrance/exit. As you vacuum, move towards the main exit and finish there.

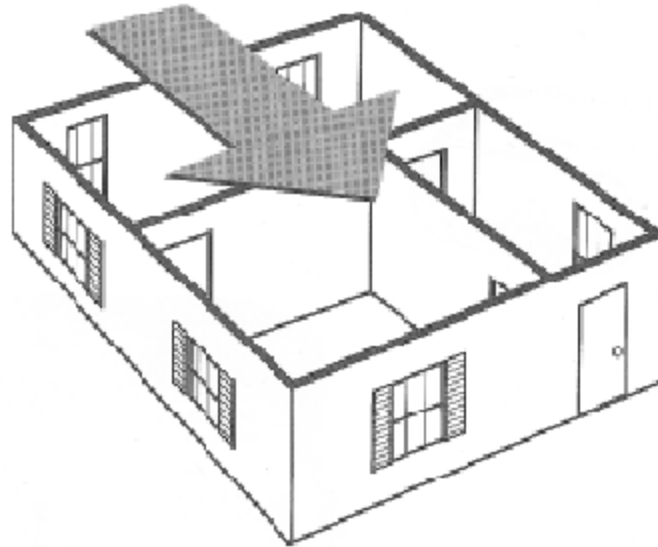

Begin at the top of each room and work down. For example, start with the top shelves, the top of the woodwork, and so on, and work down to the floor. Do every inch of the windows, especially the window troughs.

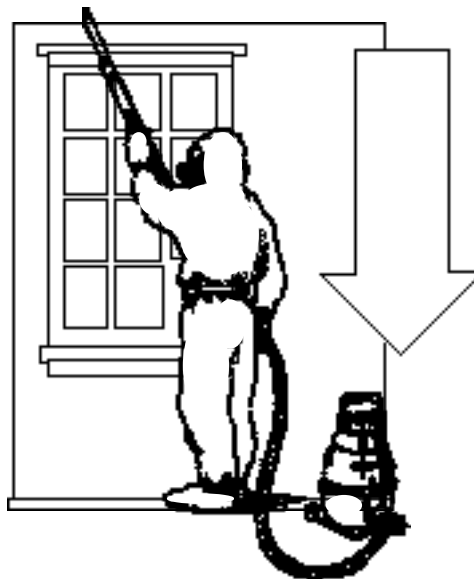



4. Use special attachments.

Use the rubber cone where the floor meets the baseboard and along all the cracks in the floor boards. Use the brush tool for walls and woodwork. Use the wheeled floor nozzle for bare floors and the carpet beater for rugs.

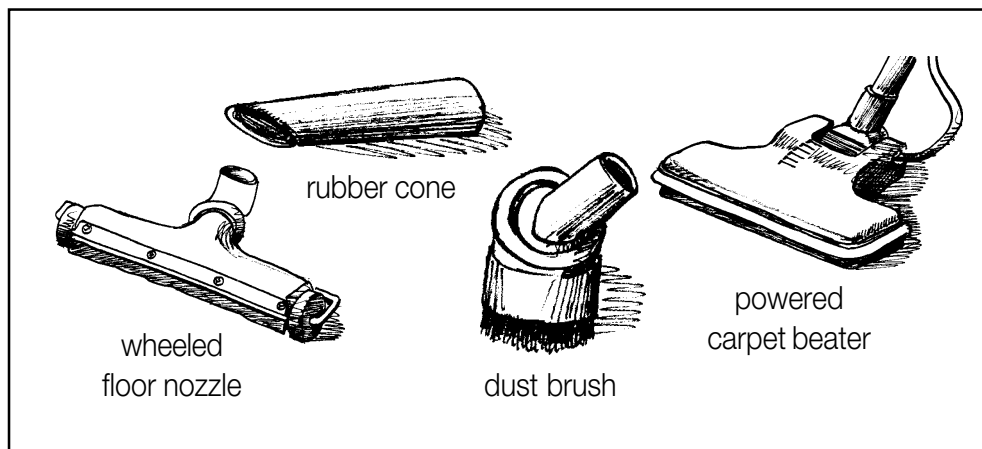

5. Maintain the HEPA vacuum.

Every now and then, you should check the HEPA vacuum for

- damaged wires
- worn gaskets and switches
- torn vacuum bag
- damaged and clogged filters

Whenever you repair the HEPA vacuum, wear protective clothing and your respirator. Repair and replace parts for HEPA vacuums in a contained work area. Replace parts as needed. Check the pre-filter often for dust and debris. Change the pre-filter when appropriate. This keeps the HEPA vacuum working properly. Use parts and filters that are the same make as the originals. Never use shop vacuum parts on a HEPA vacuum.

Wear protective clothing and your respirator. When checking the HEPA vacuum, clean it off using a second HEPA vacuum. Remember to clean up the area when you are done.

Wear protective clothing and a respirator when you repair or clean the HEPA vacuum.



Wet cleaning

Recent studies have shown that cleaning with an all-purpose cleaner or a cleaner made just for lead cleanup is very effective in removing lead dust from contaminated surfaces.

Washing with these cleaners helps get dust particles out of cracks and crevices. Remember to rinse surfaces well after washing them with any cleaner if the directions tell you to.

Some detergents contain trisodium phosphate (TSP). Cleaners such as TSP should not be used on certain surfaces, such as finished furniture. Use a tack cloth (a soft, lintless cloth that has a sticky feel to it) on such surfaces.

Phosphates such as TSP are harmful to the environment. A number of other lead cleaners may be used instead of TSP. Some states and local governments do not allow the use of TSP. Be sure to check your state and local laws.

1. Use an all-purpose cleaner or a cleaner made just for lead cleanup.

You can buy all-purpose cleaners in most hardware or janitor supply stores. Cleaners made just for lead cleanup will likely come from a safety or abatement supply warehouse.

2. Wear gloves and eye protection, if appropriate.

Some cleaning products are skin and eye irritants. Always wear gloves and protective eye gear when you use them. Refer to the MSDS for appropriate personal protective equipment. A portable eye wash should also be on site.

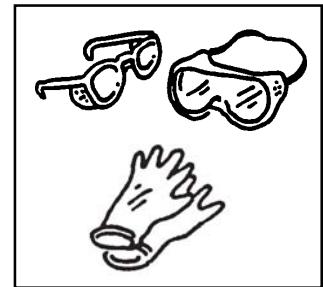

3. Mix the cleaner with water.

Follow directions on the package to make the solution. Do not use it at concentrations stronger than the instructions say.

4. Wash the area in the same order you HEPA vacuumed it.

Wipe from the far end of the area to the entrance and from the top of each room to the floor. Wash and rinse each room one at a time.

5. Use the “four-step system.”

When you wipe down surfaces with the cleaner, you will need three containers: one to hold the wash, one to squeeze the rag or mophead into, and one with clean rinse water.

There are four steps in washing with a cleaning solution. (See next page.) Go through these steps for each room in the work area. Wash and rinse each room one at a time. **Rinse carefully and thoroughly.** Some cleaners leave behind a film. If you do not rinse it off once it dries, the cleaner can damage surfaces. It can also prevent new paint from bonding to the surface.

Some cleaners can burn your skin and eyes! Wear eye protection.

Controlling Lead-based Paint Hazards



The four-step system

Step 1: Spray or pour on the cleaning solution.

Use a plastic jug or a garden sprayer to hold the lead cleaner. Pour out the lead cleaner onto the rag or mophead. This will help avoid contaminating the cleaning solution.

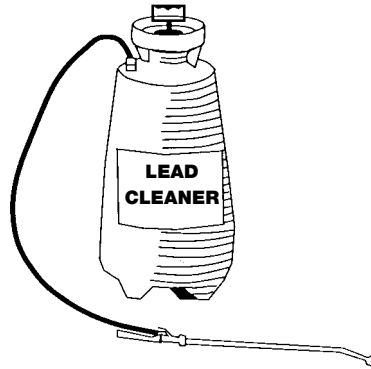

Step 2: Wash surfaces with cleaning solution.

Use rags for woodwork and a string mop for floors. Sometimes a sponge mop is used for walls. Cloth rags may be used for all surfaces.

Steps for washing with lead cleaner:

1. Spray or pour on cleaning solution;
2. Wash surfaces;
3. Squeeze out rag or mop into empty container;
4. Rinse surfaces with clean water.

Step 3: Squeeze out the dirty rag or mophead.

Squeeze out the dirty rag or mophead into an empty container.

Replace the wash rag or mophead whenever it gets loaded with dust and debris.

Repeat Steps 1 through 3 until you finish washing one room.





Rinse with a clean mophead or rag and clean water.

Rinse carefully and thoroughly.

Step 4: Rinse the surfaces.

Fill a container with clean water. Use a clean rag or mophead, and rinse all the surfaces you washed.

Squeeze the rinse rag or mophead into an empty container. Replace it when you need to.

Repeat Step 4 until you finish rinsing the room you washed. Replace rinse water as often as necessary to keep it clean. Repeat all four steps for each room in the work area.

Check your state and local laws for instructions on how to dispose of the cleanup waste water, rags, mopheads, and debris.

Remember to repeat the HEPA vacuum process.

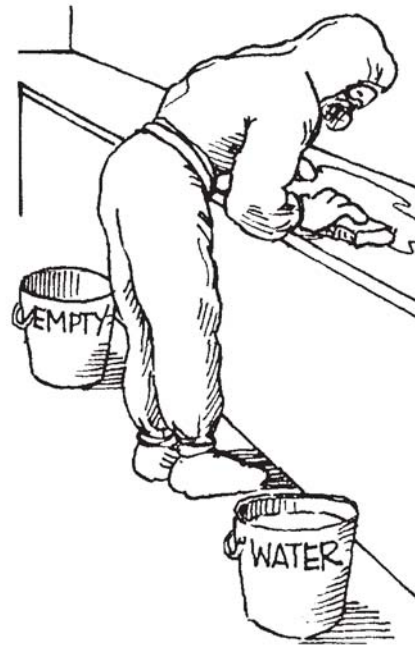



Key facts for Chapter 5



Lead-based paint hazards

Lead-based paint-dust exposure is the major cause of childhood lead poisoning.

Lead dust can be found any place where lead-based paint is flaking or damaged.

Lead-based paint can be found in many buildings built before 1978.



Title X (Residential Lead-Based Paint Hazard Reduction Act)

U.S. Congress passed Title X in 1992 to reduce the hazard of lead-based paint.

Title X has a two-step plan for reducing lead hazards: evaluating and controlling lead hazards.



Abatement means controlling the hazard.

Title X states that abatement means “removing lead-based paint hazards permanently.”

Anyone doing lead abatement must be trained and certified.



Interim controls reduce lead-based paint hazards temporarily.

Interim controls keep lead dust levels down and may prevent poisoning.

Careful cleaning is important in abatement and interim controls.

A good in-place management program can help prevent lead poisoning.

Monitor any area that you repair to make sure it stays in good condition.

Make sure the interim controls you use are legal in your area.

Anyone using interim controls should be trained and certified.



Community members, building occupants, and workers need to know about lead hazards in the building.

They need to know what is being done to make a building lead-safe.



Special cleaning requires HEPA vacuuming and washing with an all-purpose cleaner or a cleaner made just for lead cleanup.

1. HEPA vacuum all surfaces in the work area.

2. Wash all surfaces with cleaning solution.

3. HEPA vacuum all surfaces again.



Use a HEPA vacuum on lead jobs.

HEPA vacuum all surfaces from top to bottom.

Wear protective clothing and a respirator whenever you use, repair, or clean the HEPA vacuum.



Special cleaning methods must be used when abating lead.

Special cleaning removes lead dust.

Special cleaning is one of the most important jobs in abatement.



Use a cleaner on all surfaces.

Use an all-purpose cleaner or a cleaner made just for lead to wash surfaces. Check what your state and local laws require.

Some cleaners can burn your skin and eyes, so wear gloves and eye protection when you use it and have an eye wash nearby.

Use three containers: (1) cleaner; (2) empty; (3) rinse water.

Use four-step system:

1. Pour or spray the cleaner from a jug or garden sprayer onto the rag or mophead.
2. Wash all the surfaces in a room with lead cleaner. Move from top to bottom, starting from the point farthest from the exit.
3. Squeeze out the dirty rag or mophead into empty bucket.
4. Rinse all surfaces very carefully. Use clean water, rags, and mopheads.

Wash and rinse each room—one at a time.

Check your state and local laws for instructions on how to dispose of the cleanup waste water, rags, mopheads, and debris.



Special cleaning methods can be used as an interim control.



For more information

These publications have more information on the topics covered in this chapter. Your instructor will have a copy of some of the publications. You can order your own copies by calling 1-800-424-LEAD.

Residential Lead-Based Paint Hazard Reduction Act of 1992 (Title X of the Housing and Community Development Act of 1992).

EPA, *Minimizing Lead-Based Paint Hazards During Renovation, Remodeling and Repainting* (September 2000).

EPA and HUD, *Addressing Lead-Based-Paint Hazards During Renovation, Remodeling and Rehabilitation in Federally Owned and Assisted Housing* (February 2001).

EPA and HUD, *Lead-Based Paint Maintenance Training Program* (1997).

EPA, HUD, and CDC, *Lead Paint Safety: A Field Guide for Painting, Home Maintenance, and Renovation Work* (June 1999).

EPA, HUD, and CPSC, *Protect Your Family From Lead in Your Home* (June 2003).

HUD, *Guidelines for the Evaluation and Control of Lead-Based Paint Hazards in Housing* (July 1995).

NIBS, *Lead-Based Paint Operations and Maintenance Work Practices Manual for Homes and Buildings* (May 1995).

Society for Occupational and Environmental Health, *Protecting Workers and Their Communities from Lead Hazards: A Guide for Protective Work Practices and Effective Worker Training* (1993).





CHAPTER 6

SETUP

Learning objectives	6-3
Skit: Starting a new job	6-4
Discussion questions	6-4
Working with lead	6-5
Rules for lead work	6-6
Setup	6-8
Setup check list	6-8
Entering the work area	6-13
Exiting the work area	6-13
Setup for outside work	6-19
Checklist for outside setup	6-19
Setup checklist for interim controls	6-21
Key facts for Chapter 6	6-22
For more information	6-23

CAUTION

**LEAD
HAZARD**

KEEP
OUT!

Lead Abatement for Workers

Setup

Learning objectives

In this chapter you will learn

- how to keep lead out of the air
- how to protect yourself from lead while you work
- how to clean the work room
- how to set up the work room
- how to set up a decontamination area
- how to use the decontamination area

Skit: Starting a new job

Juan and Ed are getting ready to start on an abatement job in one of the houses in their neighborhood.

Juan: We need to replace this window here. Let's get into our suits and masks and start laying out the poly.

Ed: I don't need a suit and respirator. It's too hot in here.

Juan: But there's lead-based paint in this room. You need to protect yourself from the dust.

Ed: All the lead-based paint is on the woodwork. We're not going to disturb it. A respirator and a suit are just going to slow me down in this heat.

Juan: I know it's really hot in here, but you need to protect yourself so you don't get lead poisoned.

Ed: I don't want to get in trouble for working too slowly. This is the first work I've had in three months. It's hot in here.

Discussion questions

1. Do you agree or disagree with the following? Why or why not?

___ Ed and Juan don't really need to wear a suit and respirator if they are just setting up.

___ It's none of Juan's business if Ed doesn't want to wear a suit and respirator.

___ The foreman should install a fan or provide PAPRs to help keep the workers cool during setup.

___ It would be better for Ed to work without a respirator than to risk losing his job.

___ If Ed explained things to the foreman, Ed wouldn't get in trouble with him.

2. Why is Ed in such a hurry?

3. What could Juan do to convince Ed to wear a respirator and suit?

4. What could the foreman do to make it easier for Ed to wear his respirator and suit?



Setup

Working with lead

All lead paint abatement methods create lead dust.

- Lead dust is poisonous if breathed or swallowed.
- Lead dust is made up of very small particles of lead.
- Lead dust is often too small to see.
- Lead dust is heavy. Most lead particles will fall to the floor within one hour.
- Lead dust usually falls within six feet from its source.
- Lead dust settles on whatever surface it lands on.
- You can get lead dust on your hands if you touch any surface that has lead dust.

Burning lead creates lead fumes.

- Lead fumes are very dangerous.
- Lead fumes contain many tiny lead particles.
- Lead fumes stay in the air a long time.
- Lead fumes are very easy to breathe.
- Lead fumes easily go through a dust mask.

**Lead dust is
poisonous when
you breathe or
swallow it.**

**Lead fumes are
very dangerous.
They are very
easy to breathe.**

Rules for lead work

The following steps will keep lead from spreading outside of the work area. It will also make final cleanup of the work area much easier.

1. **Keep dust levels down**
2. **Contain the work area**
3. **Follow good hygiene practices**
4. **Use personal protective gear and clothing**
5. **Clean up**

Each of these steps will be discussed in the remainder of this chapter. Some of these steps will also be included in hands-on activities during this class.

1. Keep dust levels down

The purpose of lead abatement is to reduce a hazard. But, during the abatement you will stir up and even create new lead dust. **It is very important to keep lead dust levels down.** According to OSHA your employer must use methods and tools which create the least amount of lead dust. This program must be in writing and is called a compliance program. As a worker, you can control lead dust levels by

- avoiding methods that create a lot of dust and waste
- using a HEPA vacuum
- using wet methods
- cleaning up as you work
- never dry sweeping

2. Contain the work area

The OSHA Lead in Construction standard says that the work area must be separated from the non-work area. HUD says the work area must be sealed off. The work area can be contained with sheets of 6-mil polyethylene, called "poly."

Containing the work area

- protects non-lead-based painted surfaces from lead dust
- keeps lead dust from spreading outside the work area
- keeps everyone but workers away from the lead
- makes cleanup easier

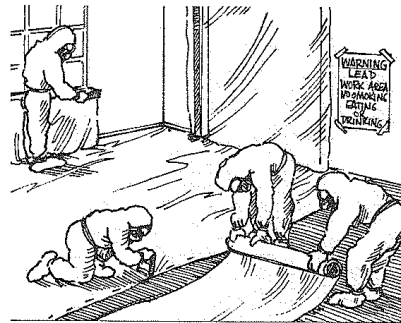

It is important to look for rips in the poly every day before you begin work. Repair any rips with duct tape as soon as you see them.

Contain the work area with poly.

Setup

3. Use personal protective gear and clothing

Your supervisor or employer is required to tell you what equipment you need to use to protect yourself from hazards on the job site. Sometimes you will have to wear a respirator and protective clothing; sometimes you will need protective eye gear, too. What protective gear you need to wear is determined by the job you are doing and the air levels of lead to which you are exposed. Always take off your disposable coveralls and booties whenever you leave the work area. Throw them away in the container labelled "LEAD CONTAMINATED WASTE" at the end of each workday. **Do not take lead dust home on work clothes.**

4. Wash up, shower, change

Wash your hands and face each time you leave the work area. Lead dust will get on you while you work. Washing up each time you leave the work area prevents you from getting lead dust in your mouth. Washing prevents you from poisoning yourself. Never eat, drink, smoke or put on makeup in the work area.



Don't take lead dust home! When your exposure to lead is above $50 \mu\text{g}/\text{m}^3$, your employer is required to provide showers whenever feasible. When showers are available, take a shower at the end of the work day. Do not wear contaminated work clothes or shoes home.

5. Cleanup

Cleanup is very important. It prevents future exposures to lead. It protects you while you work. It keeps harmful lead dust levels down. It prevents you from spreading lead dust outside the work area. Good cleanup is required for the abatement job to pass the final clearance inspection.

Washing up prevents you from poisoning yourself.

Do not wear contaminated work clothes or shoes home.

Setup

A good setup is very important on an abatement job. There are many different parts of the setup job. You have to turn off and seal off the ventilation system. You have to clean and protect the room. You may have to bring in extension cords. A good setup makes the rest of your job much easier. It also prevents many safety problems. The exact type of setup that you do will depend on your job. Your supervisor or employer will tell you what setup is needed for each job area.

It is important to think about how to set up without creating a bigger lead dust hazard. Identify the contaminated areas. Identify where the shower or wash area will be set up and **how you will move in and out of the contaminated area**. Before you do any work, find out if and when you will need to put on a suit and respirator. Check your state regulations for work area preparation.

Setup check list

- Put up warning signs
- Identify work site safety hazards
- Clean and remove anything you can move
- Shut off and seal off ventilation system
- Provide airflow for workers
- Do necessary repair work
- Shut off and lock out electricity
- Set up the decontamination area
- Clean, cover, and seal everything left in the work area
- Put up critical barriers
- Mop and seal the floor
- Bring in equipment and tools
- Seal off the work site
- Separate "dirty work" area from the rest of the work area
- Set up locked storage space for waste
- Secure the work site

Setup

CAUTION

**LEAD
HAZARD**
KEEP
OUT!

Put up warning signs

Only the people working on the lead-based paint abatement job should enter the job site. People who live in homes where work is done should pack up their belongings and stay somewhere else until the abatement job passes the final clearance inspection. Even on jobs where interim controls are being used, occupants should be out of the house during work.

The building owner needs to warn everyone in advance that lead work will be done. Warning signs need to be put up at the exits and entrances of the area to be abated. Many state and local governments say you must post warning signs. Make sure you check your state and local laws.

Some states say the contractor performing the abatement must put up warning signs on the doors leading to the work area. They must say:

CAUTION

**LEAD
HAZARD**

KEEP
OUT!!

Only the people working on the lead-based paint abatement should enter the job site.

**WARNING
LEAD WORK AREA
POISON
NO SMOKING, EATING,
DRINKING**

Warning signs let everyone know there is a lead hazard.

These signs prevent anyone from wandering onto the work site. The signs tell everyone there is a lead hazard. The OSHA lead standard says these signs must be posted if you are working above the PEL. Warning signs should be written in the language of the occupants and the workers.

Identify safety hazards and do repair work before you start the abatement.

Identify work site safety hazards

It is important to identify work site safety hazards before starting the job. You and your co-workers need to map all the safety hazards on the job site. You will look for problems like

- exposed electrical wires and switches
- water damage
- water leaks
- collapsed or damaged ceilings, walls, floors, stairs
- any other structural damage

You will need to put up warning signs that say "DANGER" until you repair the problems.

Clean and remove anything you can move

Clean and move anything you can out of the room. Large appliances such as stoves, refrigerators, washers, and dryers may be left. But gas stoves and refrigerators must be disconnected. You will move

- chairs
- desks
- computers
- bookcases
- office supplies
- machines
- paintings
- cooking pans
- books
- lamps
- tables
- and so on

Clean everything off with rags and an all-purpose cleaner or a cleaner made just for lead cleanup. Immediately rinse off the cleaner with clear water. Read the manufacturer's instructions and check for surfaces on which the cleaner should not be used. If you can't use the cleaner because it may damage the surface of the item, use a tack cloth instead. Put the used rags in 6-mil poly bags and label the bags "LEAD CONTAMINATED." Dispose of them with other waste. The wash water must be stored in noncorrosive containers. It may be hazardous waste. In some states it is illegal to pour wash water down the drain.

All cloth items must be removed and cleaned. These include clothes, curtains, carpets, and upholstered furniture. (This may not be part of the lead-based paint abatement job; it may be the owner's or tenant's responsibility.) Removing carpet kicks up a lot of dust. You might need to wear protective gear, including respirators and disposable suits.

Rugs and fabric on furniture should be cleaned. It is very difficult to clean cloth and carpets. If they cannot be cleaned, they may need to be removed. Your supervisor or employer should warn the owner about the things you cannot clean.

Do not throw anything away without the owner's permission.

Setup

If the owner agrees to throw contaminated items away, wrap them in two layers of 6-mil poly. Seal them up with duct tape. Label the items "LEAD-CONTAMINATED WASTE." Dispose of them with other abatement waste. (See Chapter 8 on Cleanup and Disposal.)

Shut off and seal off ventilation system

The ventilation air system carries air through the building. It can carry lead dust through the building. Lead dust goes where air goes. The ventilation system for the work area must be shut off at the electrical box. Lock the box and label it with a tag that says



The ventilation system is often called the HVAC system. HVAC stands for heating, ventilating, and air conditioning. Cover and seal the air vents with poly and duct tape.

Since the heat is turned off, in cold weather it is necessary to bring in other heat sources. Also be sure to protect water pipes and fixtures from freezing. If necessary, drain the pipes and wrap the water entrance from the street with electrical tape.

Provide ventilation (airflow) for workers

There are times when extra ventilation is necessary. Your employer might use a negative air machine to both ventilate the work area and clean the air. A negative air machine is like an exhaust fan with a HEPA filter. When you use a negative air machine, there must be an opening for fresh air to come in. This is called "make up air." The OSHA lead standard says you must have extra ventilation if you are working above the PEL.

Do necessary repair work

Some of the structural problems you identified at the crew's pre-job meeting have to be fixed. Collapsed stairways, ceilings, and floors can make the work area too dangerous to start the job. You will have to fix these problems before you can start the abatement work.

Check for moisture damage. If you find any moisture damage, determine the source of the moisture or water damage. Fix the source problem or inform the owner of the need to have it fixed. Roof leaks, poor flashing, bad plumbing and other water leaks must be repaired. Uncorrected water leaks will cause the abatement to fail. Walls must be allowed to dry out. Moisture in a wall can cause abatement to fail.

Moisture can cause abatement to fail.

Fix the problems or tell the owner of the need to repair.

Shut off the electricity and lock the box.

Use Ground Fault Circuit Interrupters to protect against electric shock.

Any damaged plaster will need repair if it is going to be abated. Otherwise, the method will fail. Remember to contain the area before you do this repair work.

You also need to make sure the water system is working. You will need on-site running water to wash up. You will need water for some abatement methods and for cleanup procedures. If the water service is shut off, you will have to bring water to the site.

Shut off and lockout the electrical system

Lead abatement jobs use water. This is an electrical hazard. Water can leak into an electrical outlet and kill you. For small residential jobs, you can cut off the electricity at the fuse or breaker box for the rooms that you are working on.

For large jobs, the electrical system should be shut off at the electrical box. Lock the box and label it with a tag that says

"DANGER—DO NOT OPERATE."

Turning off wall switches is not enough. Someone who does not know about lead abatement work could electrocute you by mistake.

Machines also have to be shut off. A machine with moving parts could hurt someone. It has to be turned off and locked so that people can work safely around it.

Ventilation machines, safety lights, HEPA vacuums, and hand tools all need power. Bring in extension cords for all the equipment. Extension cords are sometimes called **temporary wiring**. Tape the cords onto the walls so that workers will not trip on them. Do not hang cords with metal wire. This could cause a shock.

Cords should be hooked up to sensitive switches. These are called **Ground Fault Circuit Interrupters (GFCIs)**.

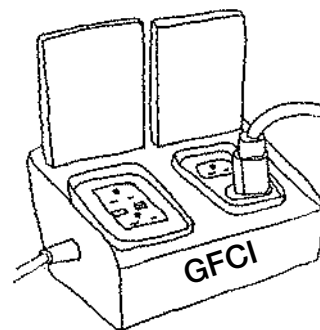
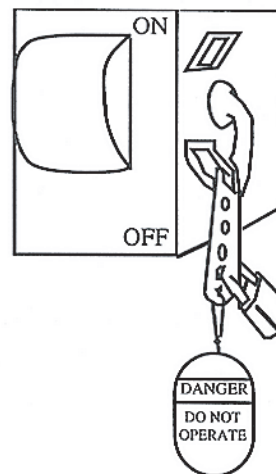

Setup

Set up the decontamination area (decon)

You go into and out of the work area through a special area. It is called the "decontamination unit" or "decon." This is where you decontaminate or get clean.

Your employer needs to set up a decon. Set up the decon in a clean area. The kind of decon you use depends on the size of the job. Some contractors build their own decons. Some use hard plastic decons. Others use decon trailers that go outside the building.

For a large-scale job, the decon may be separate rooms. These rooms should be lined with two layers of poly (hung with duct tape) and have poly flaps between them. The decon should be sealed to the work room. For small-scale work, like single unit abatement or interim control, you may not need or be able to construct a full decon. You employer is still required to provide an area to decontaminate, a wash area, and a clean changing area that are separate from the work area.

The decon has three rooms. They have to be in this order (starting from the work room)

DIRTY AREA—WASH AREA—CLEAN AREA

1. Dirty area

The dirty area must have a container to put your dirty protective clothing and used respirator filters in. This container has to have a lid that closes. The container should be labeled.

2. Wash area

The wash area must have an eye wash station, running warm water, clean towels, and soap. When possible there should be a shower. Your employer must also provide on-site toilets.

3. Clean area

The clean area must have a clean place to store your street clothes and respirator. Your street clothes should never be in contact with your dirty work clothes.

Entering the work area

Before you begin to work, you should change into your protective work clothes and shoe covers in the clean area. Store your street clothes in the clean area. Inspect, put on, and fit check your respirator. Put your hood over your respirator straps and secure with duct tape. Walk through the wash area into the equipment or dirty room. Take whatever equipment you need and go into the work area.

Exiting the work area

Every time you leave the work area, **you must exit through the decon.** Before stepping into the decon, HEPA vacuum the protective suit that you are wearing. Remove your booties and leave them in the work area. Then enter the **dirty area** of the decon. Take off your protective clothing by rolling the inside out. At the end of the day, you need to put your contaminated protective clothing in the labeled laundry container. Your

Enter and exit the work area through the decon.

Set up the decon in a clean area.

The decon area has a dirty room, shower, and clean change room.

CAUTION

**LEAD
HAZARD**
KEEP
OUT!

Lead Abatement for Workers

Everyone must enter and exit the work area through the decon.

employer must give you clean protective clothing either every day or once a week, depending on the levels of lead in the air.

Move into the **wash area**. Wash your face with your respirator on. Remove your respirator and wash your hands and face.

Clean your respirator. When you leave at the end of the day, you need to shower and wash your hair as well as wash your hands and face. Don't take lead out of the work area on your body. If showers are not available, shower and wash your hair as soon as you get home.

Move into the **clean area** with your clean respirator. Put on your clean clothes and shoes. Never wear contaminated work clothes home or bring them home to wash. They are contaminated with lead. If you take your work clothes home, you could expose yourself and your family to lead.

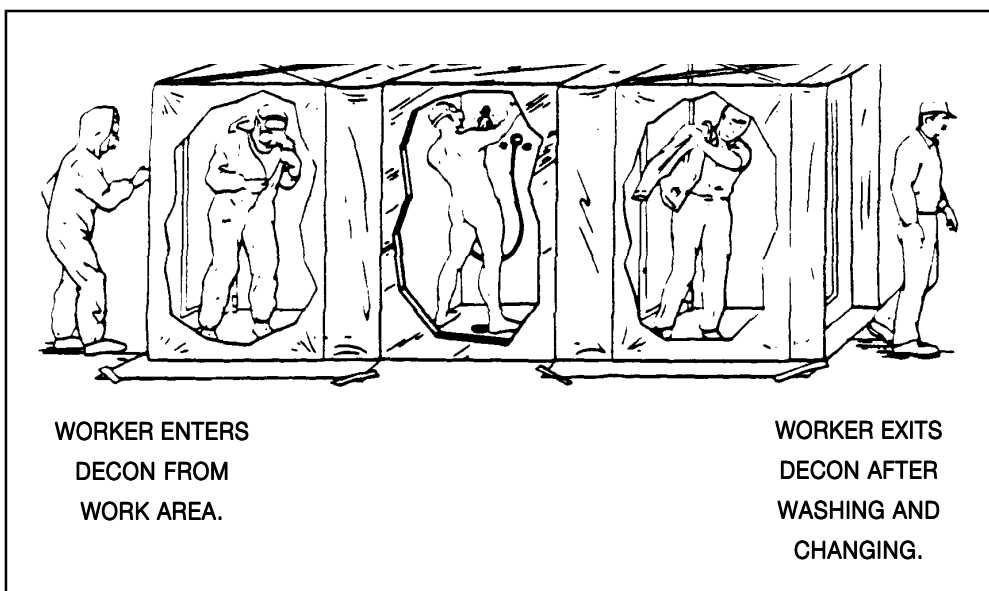

On small jobs, the doorway to the work area may be covered with overlapped poly "flap" doorways. These doorways separate the dirty area from the rest of the house or building. (See Figure 1 on the next page for two examples of these door flaps.) Check often to make sure the flaps are still stuck to the door frame.

Setup

FIGURE 1. EXAMPLES OF DOOR FLAPS WHICH SEAL OFF THE WORK AREA FROM THE REST OF THE DWELLING.

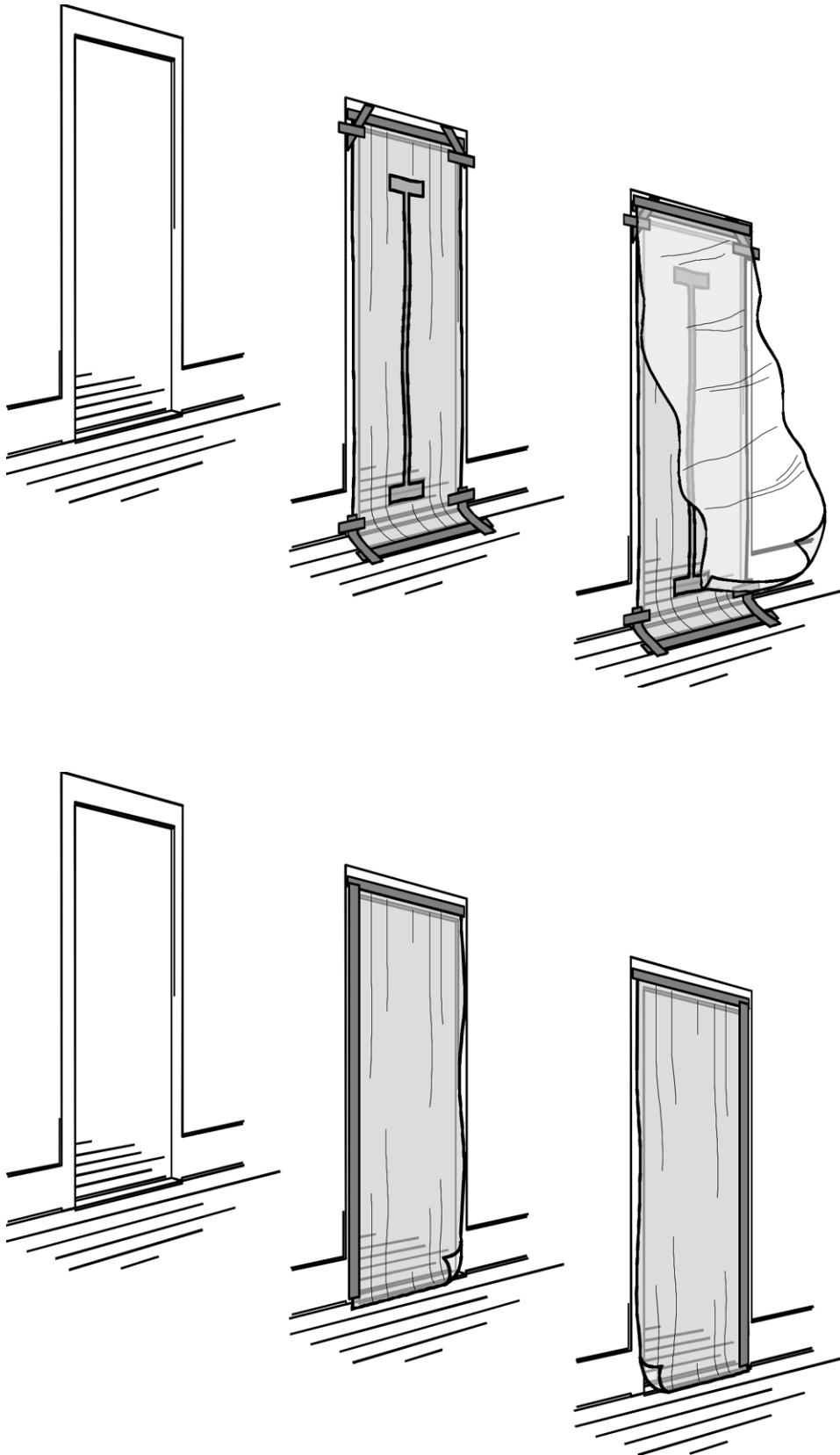

Clean and seal everything left in the work area.

Repair tears in poly as you work!

Cover floors with two layers of 6-mil poly sheeting.

Clean, cover, and seal everything left in the room

HEPA-vacuum and wipe off with a damp rag anything that you cannot remove (like a refrigerator, oven, piano, etc.). Wet mop all surfaces. Wait until the surfaces dry. Then cover and seal them with 6-mil poly and duct tape. This seal may not be broken until the final inspection. Remember to duct tape the poly to the floor.

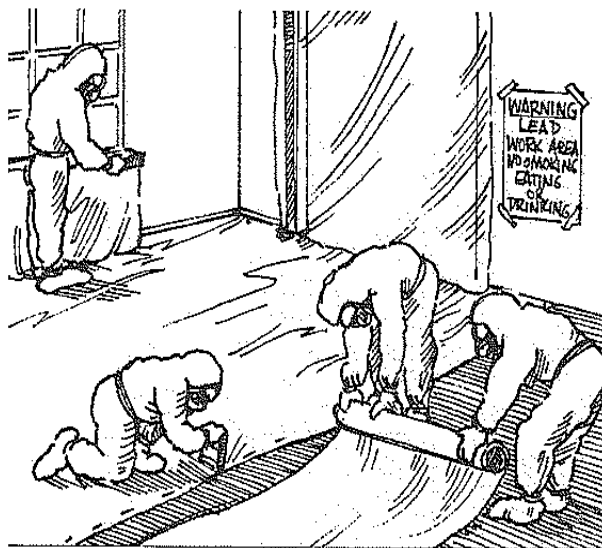

Put up critical barriers

Duct tape poly on air vents, heat ducts, windows, and any other openings. This helps prevent lead dust from escaping the work area.

Mop and seal the floor

Wet-mop the floor, particularly where the floor meets each wall. Let it dry. Cover the floor with 6-mil poly, taping it around the outside edges with duct tape. Staple the corners. When the surfaces are dry, cover the first sheet of poly with a second sheet of poly where demolition or removal will create high dust levels. Tack this layer down with small pieces of duct tape so the second layer can be taken up without pulling up the first layer.

It's important to look for tears in the poly every day before you begin working. **Repair any rips as soon as you notice them.**

Bring in equipment and tools

Be sure that all the tools you need are in the workroom **before** abatement begins. Make sure you bring all the tools and cleaning equipment that you will need for abatement. You should bring in cleaning equipment, negative air machines (if required), scaffolding, and ladders before the decon area is built and before the area is sealed.

Setup

Seal off the work site (from the rest of the building)

If you're only abating lead-based paint from **one room or one part of a building** and another part of the building is occupied, **seal off the work area from the rest of the building**. The barrier must prevent people from passing through accidentally. Examples of this kind of barrier are a locked door or plywood nailed to a frame. The edges must be sealed on all sides with duct tape to make them dust tight. **This seal may not be broken until the work is complete in this area, the area is cleaned, and the area passes final clearance.**

Workers should enter and exit from the work area through a door. If this is not possible (for example, the work area is more than three floors up), a full decon system must be used between the work area and the rest of the occupied building.

Separate "dirty work" area from rest of work area

Demolition, chemical stripping, and any other work that will generate a lot of lead dust or waste is called "**dirty work**." It is a good idea to separate "dirty work" area from the rest of the work area. Doing so helps control the transfer of dust.

- Put up two layers of 6-mil poly over the dirty area exit (air lock)
- Seal off ventilation registers (vents)
- (If possible) do not remove debris through other areas
- Avoid tracking dust from the dirty area when you move to other parts of the work area.

Set up a locked storage space for waste

Use a locked dumpster or an area that can be locked. The waste storage area must not be accessible to children or animals. Put up a warning sign that says: "DANGER! LEAD WASTE." If you use a rented dumpster, be sure the rental company knows you will be storing lead waste in it. Lay out a path of poly to the storage space. Do not track lead dust or chips from the work area to the storage area.

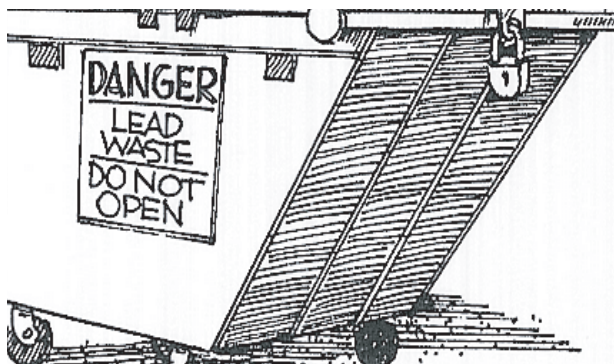

Store waste in a locked storage area.

Secure the work site

Secure the building at the end of each work day. This prevents vandalism and loss of property. It also keeps people from entering the contaminated area. Take particular care to lock doors and windows.

Setup**Setup for outside work****Checklist for outside setup**

- ___ Put up warning signs
- ___ Rope off the area
- ___ Put down the poly

Put up temporary fencing or barrier tape at a 20-foot perimeter around the surfaces on which you will be working (or less if distance to next building or sidewalk is less than 20 feet). Put up warning signs on the building and at the same distance from the working surfaces as you put the barrier tape or fencing.

Put 6-mil poly on the ground and seal it to the wall with duct tape or wood trim and masonry nails. There should be no gaps between poly and the building. You need to extend 10 feet of poly in every direction from the surface on which you are working. A disposable tarp may be laid loosely over plants. Put weights around the edge of the tarp to keep it down. Keep all windows within 20 feet of the working surfaces closed, including windows of houses or buildings nearby.

If the outside work includes window treatment or replacement, then one layer of poly should be placed on the ground and extend at least five feet beyond the perimeter of the window being treated/replaced. Two layers of poly should be taped to the *interior* wall around the window(s) to prevent dust and debris from getting inside the house.

Good setup will prevent soil from getting contaminated. When water is used to remove the lead-based paint, you need to collect **all** of the water. You can use 2 x 4s to build drains. Turn up the edge of the poly and attach the boards. Water must be contained and disposed of properly.

Do not do outside abatement work if wind speeds are more than 20 miles per hour. If it looks like it is going to rain, work must stop and cleanup must be done *before* the rain begins. At the end of each day, wrap up the poly, seal it with duct tape, and store it with other waste.

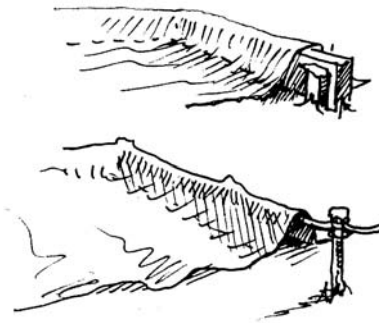

Put up warning signs around the perimeter of the exterior work area.

Lead tracking

When you walk on lead dust it can stick to your shoes or boots. It then falls in another area. This is called "**lead tracking**." Set up a path of poly to prevent lead tracking. Areas of heavy traffic should be covered with a layer of plywood.

Tracking lead dust is a big problem on lead abatement jobs. Lead dust can be tracked on your shoes from the work to outside. Sometimes lead dust from the outside soil is tracked into the work area. Lead dust from a porch or nonwork area can get tracked into a clean area. When this happens, the whole area must be cleaned again.



**Don't track lead
dust or debris
out of the work
area!**

Setup

Setup for interim controls

Anytime you disturb lead-based painted surfaces you will create lead dust. Even small jobs require appropriate set up. When performing an interim control or a maintenance repair activity, it is possible to create lead dust.

Setup checklist for interim controls

- Put up warning signs and mark off work area with tape. Keep people out of the work area
- Wear protective gear, as appropriate
- Clean and remove nearby objects. Send rugs out to be cleaned, after labeling
- Clean and seal what remains in the area
- Turn off HVAC (or turn off HVAC to that room)
- Seal air vents and other openings
- Set up dirty area, wash area, and clean area
- Place layers of poly at least six feet in every direction from the area where you will be working
- Bring all work tools and equipment into the work area
- Seal off the work site from the rest of the building

Even small jobs require appropriate set up.

Place poly at least six feet in every direction from the area where you will be working.

The following activities are **not** interim controls

- stripping
- demolition
- paint removal (scraping, sanding, etc.)
- component replacement

You must use a full abatement setup when you do any of them.

Key facts for Chapter 6

- 🔑 **Good setup makes cleaning up at the end of the job easier**
- 🔑 **When working with lead, you must**
 - keep dust levels down
 - seal off the work area
 - repair tears in poly as you work
 - wear disposable suits and booties while in the work area
 - wash your hands and face each time you leave the work area
 - shower at the end of each shift
 - clean up as you work and at the end of each shift
 - secure the work site
- 🔑 **To set up you will use the following materials**
 - disposable coveralls and booties
 - poly and duct tape
 - HEPA vacuum
 - all-purpose cleaner or a cleaner made just for lead, buckets, rags, and sponges
- 🔑 **Before doing the abatement**
 1. Clean and remove everything that you can from the work area (such as furniture, appliances, etc.)
 2. Clean and cover anything that you cannot remove with poly.
 3. Remove all carpeting.
 4. Cover all floors with poly.
 5. If you're only removing paint from one room or one part of a building, then seal off the work area from the rest of the building with poly.
- 🔑 **When doing outside abatement, keep lead from getting into the soil**
 - Good setup can prevent lead contamination
- 🔑 **During interim controls, setup is important to contain any lead dust that gets created**

Setup

For more information

These publications or resources have more information on the topics covered in this chapter. Your instructor has a copy of the publications marked with a star (*). You can order your own copy by calling 1-800-424-LEAD.

EPA, *Reducing Lead Hazards When Remodeling Your Home* (April 1994).

EPA, HUD, and CDC, *Lead Paint Safety: A Field Guide for Painting, Home Maintenance, and Renovation Work* (June 1999).

* EPA, HUD, and CPSC, *Protect Your Family From Lead in Your Home* (June 2003).

* HUD, *Guidelines for the Evaluation and Control of Lead-Based Paint Hazards in Housing* (June 1995).

NIBS, *Lead-Based Paint: Operations & Maintenance Work Practices Manual for Homes and Buildings* (May 1995).

National Lead Information Center Hotline: 1-800-424-LEAD.

CAUTION

**LEAD
HAZARD**

**KEEP
OUT!**

Lead Abatement for Workers



CHAPTER 7

ABATEMENT METHODS

Learning Objectives	7-3
Skit: On the job	7-4
Discussion Questions	7-4
Lead-based paint abatement	7-5
Replacement	7-6
Enclosure	7-7
Encapsulation	7-9
Paint removal	7-11
Prohibited methods.....	7-18
Key facts for Chapter 7	7-19
For more information	7-21



Lead Abatement for Workers



Learning Objectives

In this chapter you will learn about

- replacement
- enclosure
- encapsulation
- paint removal by
 - wet scraping and planing
 - electric heat guns
 - HEPA sanders
 - HEPA needle guns
 - chemical strippers



Skit: On the job

Abdul and Ed have been working on a house in an older neighborhood for the last two weeks. Their boss told them that the job should not take more than three weeks.

Abdul: Hey! Slow down buddy. What are you doing dry scraping that trim? You know the specs say no dry scraping.

Ed: Don't worry about it. You can just clean up underneath me as I go. I'll help you clean up once I'm done.

Abdul: Yeah, but dry scraping creates a lot of dust.

Ed: No problem. You're wearing your respirator, right?

Abdul: Respirators will only protect you so much. We're going to have a tougher time doing clean-up. You really need to slow down and cut out the dry scraping.

Ed: And you need to quit talking and start cleaning. If you can't keep up with me, that's your problem, not mine.

Discussion questions

1. Who is right, Abdul or Ed?
2. Is there anything wrong with dry scraping if you clean it up immediately?
3. Why is Abdul concerned about the dry scraping if he is wearing a respirator?
4. Do you agree or disagree with the following statements?
____ Abdul should work faster and clean up after Ed.
____ Ed should slow down and stop dry scraping.
5. Why do you think Ed is in such a hurry?
6. What could the supervisor do to ensure that no dry scraping occurs at the site?





Lead-based paint abatement

The Lead-Based Paint Hazard Reduction Act of 1992 states “abatement” refers to the methods used to permanently get rid of lead-based paint hazards. HUD has defined permanent as lasting at least 20 years. Getting rid of lead-based paint hazards means making lead-based paint unavailable, so that it is no longer a hazard. Remember, EPA defines a “paint-lead hazard” as

- lead-based paint on any friction surface that rubs against another surface and creates a dust-lead hazard
- lead-based paint that is damaged or deteriorated on any impact surface
- any chewable lead-painted surface on which there is evidence of teeth marks
- any other deteriorated lead-based paint on the inside or outside of any residential building or child-occupied facility.

There are four basic methods of lead abatement:

- **replacement**—removing the building part with lead-based paint on it and replacing it with a new one;
- **enclosure**—covering the lead-based paint with a solid barrier;
- **encapsulation**—coating the lead-based painted surface so that it is not accessible;
- **paint removal.**

Enclosure and encapsulation are permanent solutions, but these methods do not remove the lead-based paint; they abate the lead-based paint hazard.

Four methods of lead abatement

- **replace;**
- **enclose;**
- **encapsulate;**
- **remove.**



Replacement is a permanent solution.

Replacement can create a lot of dust.

Replacement

Replacement means removing the lead-painted building part (such as a window) and replacing it with a new one that is not painted with lead-based paint. This method is mostly recommended for windows, doors, and other woodwork that are painted with lead-based paint.

Advantages

Replacement is the easiest and quickest way to get rid of lead-based paint. Replacement removes lead-based paint forever. It is a **permanent solution**. When combined with overall modernization, replacing windows can upgrade the building itself. Replacement can lower heating bills and maintenance costs.

Disadvantages

Replacement is expensive. It takes a lot of work. Skilled carpenters are often needed to put in the new parts—especially windows and doors. Surfaces next to the part being removed may get damaged. The replacement part may not be as good as the original.

Replacement can involve demolition work. It can create a lot of dust. To keep lead levels down, wet mist and HEPA (High Efficiency Particulate Air)-vacuum the old building part before removing it.



Replacement often requires manual demolition. Old building parts must be torn out and removed. Manual demolition is a Class 1 task under OSHA. You must wear an appropriate respirator and protective clothing unless your employer has sampled the air for lead and this job does not release a lot of lead dust into the air. Lead abatement tasks are identified in OSHA's Lead in Construction Standard and defined in Chapter 3 of this manual. After removing the building part, wet mist the part again, wrap it in poly, and seal it with duct tape. Store it until it can be disposed of properly. Wet down and clean up debris as you work. This helps keep lead dust levels down. You will learn more about cleanup and waste disposal in Chapter 8.



Enclosure

Enclosure means covering the lead-based paint with a solid, dust-tight barrier. The lead-based paint is enclosed behind the barrier. An enclosure keeps the lead-based paint away from the rest of the building. It keeps lead away from the building occupants.

The materials used to enclose the lead-painted surface must be durable. Common materials used to build enclosures include:

- underlayment
- aluminum
- panelling
- fiber board
- vinyl
- plywood
- drywall
- tile
- acrylic sheets

Wall paper and contact paper are **not** enclosure materials. They are not dust-tight.

Before you enclose a surface, remove all peeling and chipping paint. Also fix any “source problems” such as water leaks or moisture sources. If source problems are not fixed, the enclosure that you build will get damaged and fail. After fixing the source problem, HEPA vacuum the area to be enclosed. This will collect any loose lead dust.

An enclosure is a dust-tight, solid barrier.

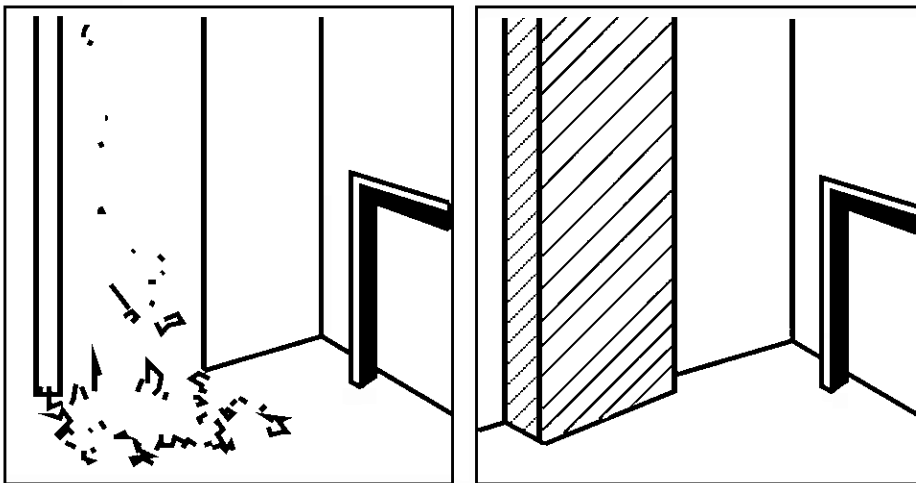

AN ENCLOSURE KEEPS LEAD-BASED PAINT AWAY FROM OCCUPANTS AND THE REST OF THE BUILDING.



An enclosure prevents lead dust from leaking out.

Label the surface “LEAD-BASED PAINT” before you enclose it. Use spray paint or something similar.

When you enclose a surface, make sure that the lead dust will not leak out of the edges or seams. Seal all seams with caulk. Back-caulk the perimeter of the enclosure material before you install it. Then mechanically attach the enclosure material to the lead-painted surface. Use nails or screws. You need to use both adhesive and physical fasteners to create a dust-tight seal. A dust-tight seal prevents lead-dust leaks.

The new surface must stay in place. The enclosure must be made so that no one, especially not a small child, can remove it. The enclosure material must be strong and durable. If there are building plans, the areas where enclosures cover lead-based paint need to be marked and identified in the plan. This will show workers who work in the building in the future that lead is located there.

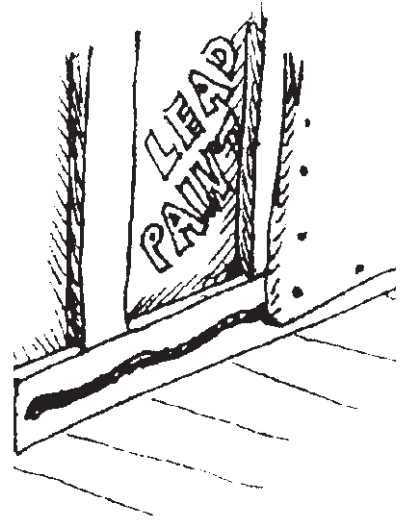

Advantages

Enclosures are made using locally available construction materials. Enclosures are durable and, if done right, don't create much waste or dust.

Disadvantages

Enclosure does not permanently remove the lead-based paint. The lead source still remains underneath the covering. Renovation or repair work to enclosed surfaces will disturb the lead-based paint. It will release lead dust that has collected behind the enclosure barrier. Enclosed surfaces and joints of the enclosures must be monitored for damage and deterioration.

An enclosure does not permanently remove lead-based paint.



Encapsulation

Encapsulation means coating the lead-painted surface with a thick, durable sealing material. Surface preparation is critical when encapsulants are used. Some systems include a mesh as well. The coating prevents lead dust from being released. Encapsulants are best used on building materials that are in good condition. You need an encapsulant with mesh for surfaces that have some chipping or peeling.

Encapsulants must be strong enough so you can not easily break or chip the surface. They must completely cover the lead surface and have a dust-tight seal. Encapsulants must be flexible and strong. You should not be able to damage the encapsulated surface with impact. Make sure that the encapsulant you use is not toxic and that it is flame resistant. Read the MSDS (Material Safety Data Sheet). Wallpaper, contact paper, and new paint **are not** encapsulants.

There are many different kinds of encapsulants on the market. The quality and reliability of encapsulants vary greatly. ASTM has developed three standards for encapsulants. Only encapsulants that meet these standards should be used. Check your state and local laws. In some areas of the country, encapsulants must be approved by state or local government on a case-by-case basis.

Preparing the surface

You must follow all of the manufacturer's instructions on how to prepare the surface. The wall or surface must be in good condition to use encapsulants. Encapsulation will not work if the wall is separating from the wood or lath. It will not work if the plaster is separating. It will not work if the surface is very damaged or deteriorated.

The surface to be covered needs to be prepared first. Moisture sources must be removed and the surface allowed to dry. Peeling paint should be wet scraped. The surface should be wet cleaned and allowed to dry. (You can use a HEPA vacuum to clean the surface if a wet cleaning is not recommended by the manufacturer.) If these steps are skipped, the encapsulant will fail.

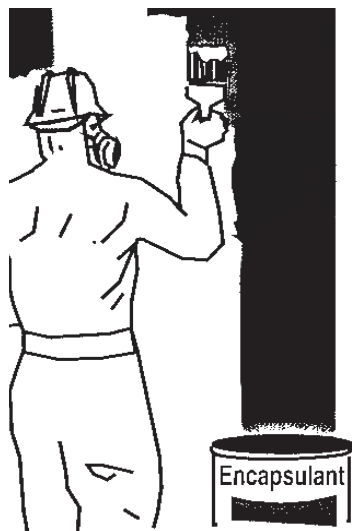

Applying the encapsulant

You must follow all of the manufacturer's instructions on how to apply the encapsulant. Encapsulants are usually easy to apply. Often they can be applied like you apply paint. **If the encapsulant is improperly applied, it will fail.** It can separate from the paint. This will cause the paint to peel and create lead dust.

It is best to use encapsulants on building materials that are in good condition.

Make sure it is legal to use the encapsulant in your local area.

You must prepare the surface.

Follow directions when you use an encapsulant.



Always do a "test patch."

Encapsulation does not remove the lead-based paint.

Doing a test patch

Not all encapsulants can be used on all surfaces. Some encapsulants will not work on certain surfaces. For this reason, you must do a "test patch" of the encapsulant on the surface to be covered. Read and follow the manufacturer's instructions. If the test patch bubbles or cracks, then it has failed. If the test fails, do not use this encapsulant on this surface. Test other encapsulants or use another abatement method.

Using the right personal protective equipment

The type of personal protective equipment you need depends on the type of encapsulant you use. Suits and respirators should be worn when you do any repair work before applying the encapsulant. For some chemical encapsulants, you will need special filters, and chemical-resistant gloves and suits. When using some encapsulants you will need to use an organic vapor filter as well as a HEPA filter on your respirator.

Make sure the area has a good flow of air. You might need extra ventilation. Good ventilation is very important when using an encapsulant. Be sure to check the product's MSDS for specific safety measures.

Advantages

Encapsulation usually does not generate a lot of dust. It may be less costly than other abatement options. A wide range of products meeting the ASTM standards is available.

Disadvantages

Encapsulation does not permanently remove the lead-based paint. The lead source still remains underneath the covering. Any renovation or repair work to encapsulated surfaces will disturb the lead-based paint. Encapsulants do not work on all surfaces. They need to be tested. "Patch testing" the encapsulant takes time.

Encapsulated surfaces need to be inspected regularly for damage and deterioration. Encapsulants can fail, especially if the underlying surface was not properly prepared or the encapsulant was not applied correctly. Sometimes encapsulants separate from the surface. This is called encapsulant failure. Encapsulants should not be used on impact or friction surfaces.

Using some encapsulant products may create hazardous waste. Hazardous waste has to be disposed of properly. You will learn about disposal of hazardous waste in Chapter 8.



Paint removal

Removal means taking off lead-based paint. **Removal methods create a lot of lead dust and waste.** To begin, wet mist and HEPA vacuum old building parts. Clean up debris as you work. Keep lead-dust levels down. Paint can be removed by using one or more of the following methods:

- wet scraping down to the substrate
- wet planing
- using electric heat guns
- using local-exhaust hand tools
- chemical stripping
- vacuum and water blasting (exterior only)

Wet scraping

Wet scraping means misting loose paint before scraping it. Dry scraping paint creates a huge amount of dust. Avoid dry scraping lead-based paint. Mist the loose paint before you scrape it. Continue to wet it while you scrape. Doing this keeps lead dust levels down.

Wet scraping is often used to prepare a surface for painting. It does not mean removing all of the paint—only the loose paint. Wet scraping and painting can be used as an interim control.

WARNING: Never wet surfaces near electrical outlets even if the circuit is turned off. You could get an electric shock.

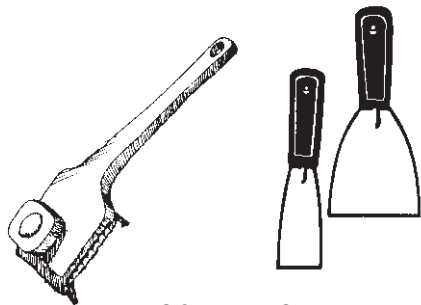

SCRAPERS

A scraper is a blade-like tool used to remove paint. They come in different sizes. Scrapers should be kept sharp at all times. A mill file is good for keeping scrapers sharp.

Clean up the paint scrapings and dust as you work. Wet and bag the debris as you go. This keeps lead-dust levels down.

Manual scraping is a Class 1 task. To be

safe, wear appropriate respiratory protection and disposable suit, gloves, and goggles when you wet scrape. You will get a lot of paint chips and lead dust on your disposable suit. HEPA vacuum the outside of your suit as you exit the work area.

Removal methods create a lot of lead dust.

Wet the paint before you scrape it.

Clean up as you work.



Wet the paint before you plane it.

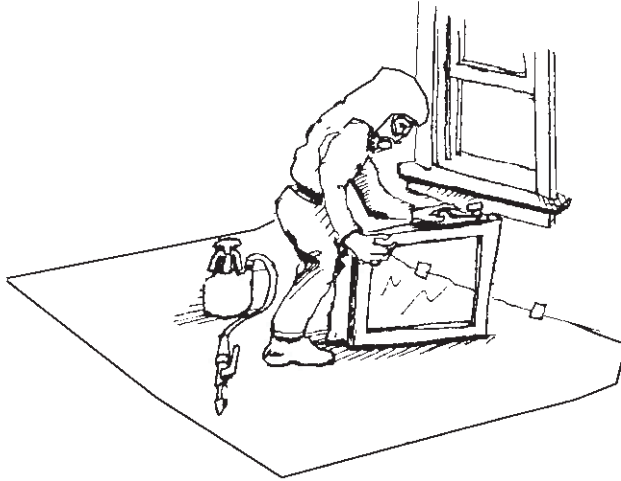

Wet planing

Wet planing is much like wet scraping. It means misting the surface before you plane it. Wet planing creates dust. Wear a respirator and protective clothing to be safe.

A plane is a carpenter's tool for shaving a wooden surface. You can use a plane to remove lead-based paint from impact surfaces such as

the edges of a door. You can use a plane on friction surfaces such as the edges of windows that rub together when you open or close the window.

Electric heat guns

Heat guns that generate heat of 1,100° F or more are prohibited. Electric heat guns may be used to force warmed air onto a painted surface. The heat softens the paint. The loosened paint is then scraped off with hand tools.

Use heat guns very carefully. Heat guns can cause serious burns on your skin. They can damage the building material from which you are removing paint. They can even cause a fire. Before using a heat gun, check the building material and the other side of the wall. Heat guns can ignite a fire on the other side of the surface material. **Have an ABC (multiuse) fire extinguisher on hand.**

Heat guns that operate at 1,100° F or more can cause lead-based paint to produce toxic fumes. Fumes are created when a metal is heated. Lead fumes contain many tiny particles of lead. These tiny particles are very easy to breathe. The lead fumes quickly travel deep into your lungs and then cross into the blood. Heat can also cause the paint to release organic vapors. Organic vapors come from chemicals used to make paint. High heat can turn the chemicals into dangerous vapors.



Do not use a heat gun above 1,100° F.

Heat guns can burn you and the building.

Heat guns can create dangerous lead fumes.



You should wear a Powered Air Purifying Respirator (PAPR) when you use a heat gun to protect yourself against dust and fumes. The PAPR should have both a HEPA filter and an organic vapor cartridge. Some states say you **must** wear a PAPR when using a heat gun. You are dry scraping when you use a heat gun. This could create a lot of dust. Using a heat gun is a Class 1 task. The OSHA Lead Standard says you can ask your employer for a PAPR. If you ask for a PAPR, your employer must provide you one if you are working above the PEL and it is protective against the contaminants in your work area.

Local exhaust hand tools

Local exhaust hand tools are power tools that you can hold in your hand. They have a hose that attaches to a vacuum, which has a HEPA filter. This system is called a local HEPA exhaust system. There are a number of local exhaust hand tools for lead-abatement work. Using local exhaust hand tools is a Class 1 task.

Follow the manufacturer's instructions for proper use of local exhaust hand tools. Never remove or pull back the shroud or cover. The cover is needed for the vacuum to work. Shrouded tools are difficult to use. Sometimes you cannot see what you are doing. **You must move the tool very slowly to keep the shroud in place.** The tool must be used flat against the surface. If you work too fast, the shroud seal will break and lead dust will get into the air.

- **HEPA sanders**

Sanding generates huge amounts of dust. A HEPA sander is a power sander fitted with a HEPA vacuum to catch and filter lead dust as it is created. Always use a HEPA sander when you sand lead-based paint. Limit the use of HEPA sanding to flat surfaces for feathering or finishing only.

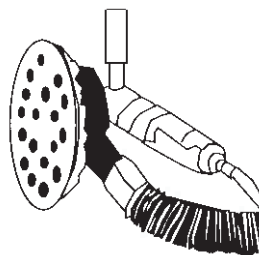

HEPA SANDER

- **Needle gun with HEPA filter**

A needle gun has many metal rods. The rods are contained inside a shroud (cover). The rods loosen and break the surface paint. The shroud catches most of the lead dust. The local exhaust pulls them into the HEPA filter.

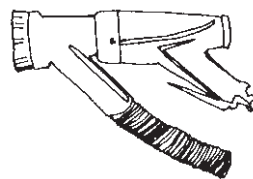

HEPA NEEDLE GUN

Needle guns are best used on metal or masonry surfaces. They are useful on pipes and structural steel. They will damage wood surfaces. **Wear hearing protection when you use a needle gun.**

Local exhaust tools have a HEPA vacuum attached to them.

Sanding generates large amounts of dust.



Do not use sanders, saws, drills, or needle guns without a HEPA attachment.

Chemical stripping strips paint with solvents or caustic paste.

- **HEPA saws and drills**

Other hand tools, such as saws and drills, can be fitted with HEPA exhaust systems. The HEPA system catches and filters most of the lead dust as it is created. The drill, like the needle gun, has a cover. **Wear hearing protection when you use a HEPA saw or drill.**

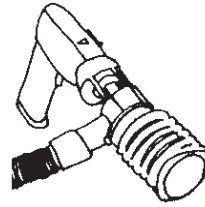

HEPA DRILL

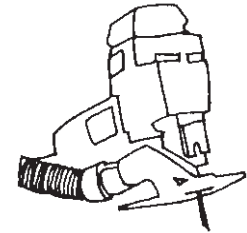

HEPA SAW

Chemical stripping

The use of chemicals in the form of solvents or caustic paste to strip off paint is called chemical stripping. Chemical solvents dissolve the paint. Caustic paste melts paint into a goo that is scraped off with hand tools. Chemical stripping always involves manual scraping. **Wear eye protection, a respirator, and protective clothing to be safe from the chemicals and from lead. Chemical strippers give off harmful chemical vapors. You will need to wear combination filters on your respirator.**

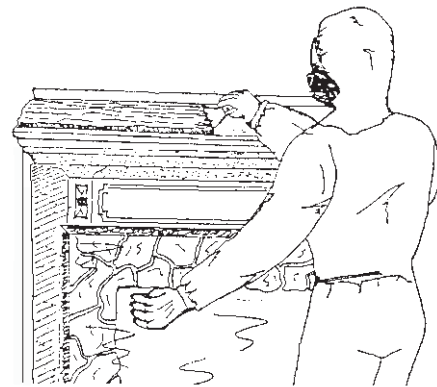

After the paint is removed, carefully clean the surface. Then use a special rinse to neutralize the surface. The rinse balances the acid or base of the stripping chemicals. Check with pH indicators to make sure the neutralizer worked. Repainted surfaces will fail if the caustic paint stripper is not completely removed and the surface is not neutralized. The surface may need to be smoothed and reglued before it is repainted.

Chemical stripping can be done on- or off-site. When chemical stripping is done off-site or when you send painted material off-site to be stripped, you should wet down and clean up any debris generated when you remove the component. Mark the component in order to identify the place that it was removed from. Place such markings in an out-of-the-way place. Be sure to use markings that will not be removed by stripping products (i.e., engraving). Mist the building part with water and remove it. Wrap it in poly. You may need to wear a respirator and protective clothing when you do this.

Send the component to a professional stripping shop. At the shop it will be dipped in a tank full of chemical stripping agents. The paint will dissolve right off the surface.

Abatement Methods



When the component is returned, be sure to wash it before you reinstall it. Make sure it is properly neutralized. You may also need to refinish and reglue it. Remember to wear a respirator if you sand the surface—chemical stripping always leaves some lead behind.

Advantages

Chemical paint strippers are useful to preserve the detail on decorative doors, molding, and trims. They are used on old antique trims or molding that can not be replaced.

Sending the work somewhere else keeps hazardous chemical strippers out of your work area.

Disadvantages

Chemical strippers may create hazardous waste. Strippers are often made of hazardous materials and may have to be disposed of as hazardous waste. The liquid waste generated through rinsing and cleaning may also be hazardous waste. Hazardous waste has to be contained and disposed of in a special way. It must be handled correctly, or it can hurt workers and the environment. Sending the work off-site protects you and your work site. It does not protect the work site or workers where the stripping takes place. Your employer is required to find out if each job generates hazardous waste.

Chemical stripping leaves some lead behind. This leftover lead soaks into the pores and cracks of a surface, especially wood, where it hardens. Wear a respirator if you sand the surface. Clean the stripped surface carefully, or the leftover lead will mix with the new non-lead-based paint. When the new paint chalks, chips, or peels, the lead will get into the dust all over again. Clean up any dust or debris using wet cleaning methods and HEPA vacuuming.

Caustic strippers can damage the building material.

Leftover stripper will cause the new paint coat to fail. It will damage the building material. This can happen if the surface was not cleaned properly. Cleaning is an important job that takes a lot of time. Another reason the new paint might fail is that the neutralizer did not work properly. It is very important to test the surface to see if the neutralizer has worked. If the surface is not neutral, you must clean and neutralize it again. Do this process over and over until the surface is neutral. This could take days.

Removing a building component for off-site stripping will create dust. An old building component may break when you try to remove it. To keep dust levels down, mist the component with water before you remove it. Wet down and clean up any debris generated. Wear the right protective gear and follow proper hygiene practices.

Chemical strippers are dangerous!

Material Safety Data Sheets (MSDSs) give you safety instructions about using chemical products.

Chemical stripping creates hazardous waste—both on site and off site.



Read your Material Safety Data Sheets.

Any chemical that can remove paint will harm you if it touches your skin or gets in your eyes.

Caustic strippers will burn your skin. When you scrape a caustic, it can create a dust or mist that can get into your eyes, nose, mouth, and throat. Solvent strippers can be very dangerous. Some solvents can damage your skin, others pass through your skin into your blood. Solvents can damage your brain, nervous system, blood, liver, kidney, and heart.

- Find out where the eye-wash station is so you know where to find it if you need it.
- Never do chemical stripping above your head.
- Keep chemicals off your skin and out of your eyes.
- Wear chemical-resistant, rubber gloves and suits. Wear eye goggles and gloves that extend up your arm towards your elbows.

Some stripping chemicals have toxic vapors which you should not breathe.



- **Do not use strippers that contain methylene chloride.** Methylene chloride is extremely toxic. It can cause cancer and other major health problems.
- Only use chemical strippers in well-ventilated areas.
- Use the right respirator filters. Make sure your respirator cartridges will protect you from the chemicals in the stripper. You may need a combination filter when you are removing lead with a chemical stripper.

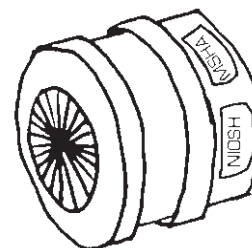



Some strippers can cause a fire. The vapors they give off create a fire hazard.

- Do not use them around electric heaters, heat guns, or any electrical equipment.
- Have an ABC fire extinguisher on hand.
- Have a plan in case of a fire.
- Mark and know where the emergency exits are.
- Post the emergency phone numbers.
- Know where the phone is and how to use it.
- Have a designated meeting place outside the work area.



Vacuum and water blasting (exterior methods)

Paint can be removed by vacuum blasting and water blasting. These methods are to be used for **exterior work only**. Vacuum blasting requires a HEPA vacuum. Both methods are very expensive. They create a lot of waste. They can damage the treated surface, especially wood. Neither method is used very often. **Vacuum blasting** can be used on a variety of surfaces, but it works best on flat surfaces. **Water blasting** creates waste water that is considered hazardous. It must be contained and disposed of properly.

After the lead-based paint is removed, the bare surface must be cleaned and smoothed. Then, the surface must be inspected. If it passes inspection, it can be repainted with non-lead-based paint or covered with other materials.

Only use vacuum and contained water blasting for outside work.



Torching and flame burning lead-based paint are not allowed in residential abatement.

HUD does not allow the use of paint strippers in poorly ventilated work spaces.

Wall papering and painting are not lead-based paint abatement methods.

Prohibited methods

HUD and EPA do **not** allow some methods on residential lead abatement jobs (including child-occupied facilities). These methods are not allowed because they are hazardous. They include

- torch or flame burning;
- machine sanding or grinding (unless equipped with a HEPA filter);
- abrasive blasting or sandblasting (unless equipped with a HEPA filter);
- dry scraping of lead-based paint*;
- using a heat gun above 1100 degrees Fahrenheit.

*Dry scraping of lead-based paint is only allowed in the following situations:

- when scraping while using a heat gun or around electrical outlets;
- when scraping defective paint spots totaling no more than two square feet in any one room, hallway or stairwell or totaling no more than 20 square feet on exterior surfaces.



NO TORCH BURNING!

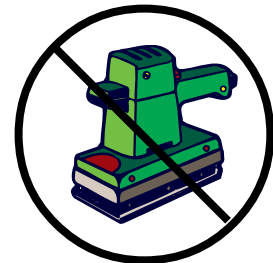

NO DRY SANDING!

Additionally, HUD prohibits the use of methylene chloride paint strippers, as well as the use of other paint strippers in poorly ventilated work spaces.

Some states or localities may prohibit the use of methylene chloride paint strippers. Methylene chloride paint strippers may cause cancer.

Remember, wallpapering or repainting *are not* lead-based paint abatement methods.



Key facts for Chapter 7

 Always wear a respirator and protective clothing when doing abatement work.

 Clean up as you work.

There are four methods to abate lead-based paint:

- Replacement
- Enclosure
- Encapsulation
- Paint removal

 Replacement permanently removes the lead-based paint.

Replacement can increase the value of the building.

It can create a lot of dust.

Wet mist before removing the old part.

Clean up as you work.

 An enclosure is a dust-tight solid barrier.

A dust-tight enclosure prevents lead dust from leaking out.

Lead-based paint remains.

The surface must be HEPA vacuumed before enclosure.

The enclosure must be strong and durable.

 Encapsulation means coating the lead-painted surface with a thick, durable sealing material.

Encapsulation is best used on building parts in good condition.

Whenever you encapsulate, you must prepare the surface first.

Always do a “test patch.”

Lead-based paint remains.

Encapsulants may fail.

Make sure the encapsulant you use is legal in your area.

 Paint removal methods create a lot of lead dust.

Mist the paint before you scrape or plane it.

 Heat guns may create dangerous lead fumes and toxic vapors.

Do not use a heat gun that heats above 1,100° F.

Heat guns can burn you and the building.

Wall papering and painting are not lead-based paint abatement methods.



- **Use only local exhaust tools that have a HEPA vacuum attached to them to remove lead-based paint.**

Mechanical hand tools create large amounts of dust.
- **Only use sanders, saws, needle guns or drills that have a HEPA attachment.**
- **Chemical stripping removes paint by means of solvents or caustic paste.**
- **Chemical strippers are dangerous!**

Chemical stripping may create hazardous waste—on site and off.

Wear chemical-resistant coveralls, gloves and booties.

Always wear eye protection.

Do not use strippers that contain methylene chloride.

Some strippers can create a fire hazard.

Make sure you have an ABC fire extinguisher on site.
- **Vacuuming and water blasting should only be used for outside work.**
- **HUD and EPA do not allow these lead-abatement methods for residential work:**
 - torch or flame burning;
 - machine sanding or grinding (unless equipped with a HEPA filter);
 - abrasive blasting or sandblasting (unless equipped with a HEPA filter);
 - dry scraping of lead-based paint (with a few exceptions);
 - using a heat gun above 1,100 degrees Fahrenheit.
- **HUD does not allow the use of paint strippers in poorly ventilated work spaces.**



For more information

These publications have more information on the topics covered in this chapter. Your instructor has a copy of the publications marked with a star (*). You can order your own copies by calling 1-800-424-LEAD.

*EPA, *Lead: Identification of Dangerous Levels of Lead; Final Rule*; 40 CFR Part 745 (January 2001).

*EPA, *Lead: Requirement for Lead-Based Paint Activities in Target Housing and Child-occupied Facilities*; 40 CFR Part 745 (August 1996).

*HUD, *Requirements for Notification, Evaluation and Reduction of Lead-Based Paint Hazards in Federally Owned Residential Property and Housing Receiving Federal Assistance; Final Rule* (September 1999).

*HUD, *Guidance for the Evaluation and Control of Lead-Based Paint Hazards in Housing* (July 1995).

*NIOSH, *Preventing Lead Poisoning in Construction Workers*, NIOSH Document No. 91-116A (April 1992).

*OSHA, *Interim Final Lead in Construction Standard*, 29 CFR 1926.62 (May 1993).

OSHA, *Lead in Construction*, OSHA 3142 (1993).

*Society for Occupational and Environmental Health, *Protecting Workers and Their Communities from Lead Hazards: A Guide for Protective Work Practices and Effective Worker Training* (1993).



Lead Abatement for Workers



CHAPTER 8

CLEANUP, DISPOSAL, AND CLEARANCE

Learning objectives	8-3
Skit: A home abatement job	8-4
Discussion questions	8-4
Cleanup of lead dust	8-5
Cleanup materials	8-6
Daily cleanup	8-7
Final cleanup	8-9
Clearance Inspection	8-12
Visual examination	8-12
Stage 2: Painting and sealing	8-12
Stage 3: Repeat special cleaning	8-12
Final inspection—Environmental sampling	8-13
Clearance dust levels	8-13
Why measure lead in house dust?	8-14
Waste from a lead abatement job	8-15
Handling waste on the job	8-17
Liquid waste	8-18
Testing and disposing of waste	8-19
Nonhazardous waste disposal	8-20
Hazardous waste disposal.....	8-21
EPA studies of paint abatement waste	8-23
Key facts for Chapter 8	8-24
For more information	8-26
Addendum A.....	8-27



Lead Abatement for Workers



Learning objectives

In this chapter you will learn

- the importance of good cleanup
- what cleanup materials to use
- how to do daily cleanup
- how to do final cleanup
- what the clearance levels are
- how to handle waste
- how to dispose of hazardous waste



Skit: A home abatement job

It's 4:30 in the afternoon, and Paul and Pam are just finishing cleaning up for the day.

Pam: Hey, I can see a little bit of dust left on the floor. I'll bring in the shop vacuum and clean it up.

Paul: Don't do that. Use the HEPA vacuum.

Pam: Didn't you hear that the HEPA vacuum broke this morning? Besides, we already did a thorough vacuuming yesterday.

Paul: Why don't we spray it down and then sweep it up?

Pam: That will take too much time. I've got a date tonight and I want to get out of here before the next shift comes in and removes the poly. Don't worry about it. I'm gonna vacuum and when I'm done it'll look really good.

Discussion questions

1. Is it okay to use a regular shop vacuum to clean up the lead dust as long as you're inside the contained area?
2. If you are inside of the enclosed area, do you need to worry about kicking up the lead dust?
3. What makes lead-paint dust and chips so hard to clean up?
4. If Pam uses the shop vacuum, how could it affect the people on the next shift? How could it affect the next person who uses the shop vacuum?





Cleanup of lead dust

Cleanup is the most important step.

If you do not clean up, lead dust levels will increase! Careful cleaning prevents future exposures to lead. Careful cleaning protects the family who will move back into the homes you work on. Any lead dust that remains can poison them. Careful cleaning also protects you while you work.

Lead dust is difficult to remove because

- lead dust is very fine
- it may not be visible
- it sticks to surfaces
- it has to be rubbed off
- it collects and packs into cracks

Careful cleanup
keeps lead dust
down.



Cleanup materials

- Protective suit and respirator
- Work gloves and eye protection
- Hand-pumped water sprayer
- Water
- Labelled heavy-duty plastic bags (6-mil poly)
- Plastic shovels and/or dust pans
- HEPA-vacuum cleaner (with special attachments)
- All-purpose cleaner or a cleaner just for lead cleanup
- Buckets (at least 3 mop buckets, one with a wringer)
- Sponges and rags
- String mops, sponge mops, and extra mop heads for both
- Clean step ladder
- Special containers for hazardous waste (if needed)



Daily cleanup

Cleaning the work site every day helps to keep lead dust levels down. It keeps the work area as clean as possible. The OSHA Lead Standard says all surfaces must be kept as free from lead dust as is practical. This keeps lead out of the air. Cleaning the work site prevents you from spreading lead dust around. It also helps make final cleanup—and passing the final inspection—much easier. You may be exposed to high levels of lead in cleanup. You must wear a respirator and protective clothing during cleanup. Daily cleanup takes place at the end of each work day.

1. Wrap up and label large debris.

Wrap large debris (like doors and windows) in 6-mil poly. Seal the wrapped debris with duct tape. Put a label on it that says “LEAD CONTAMINATED.” Store waste in a secure area until it can be tested and disposed of properly.

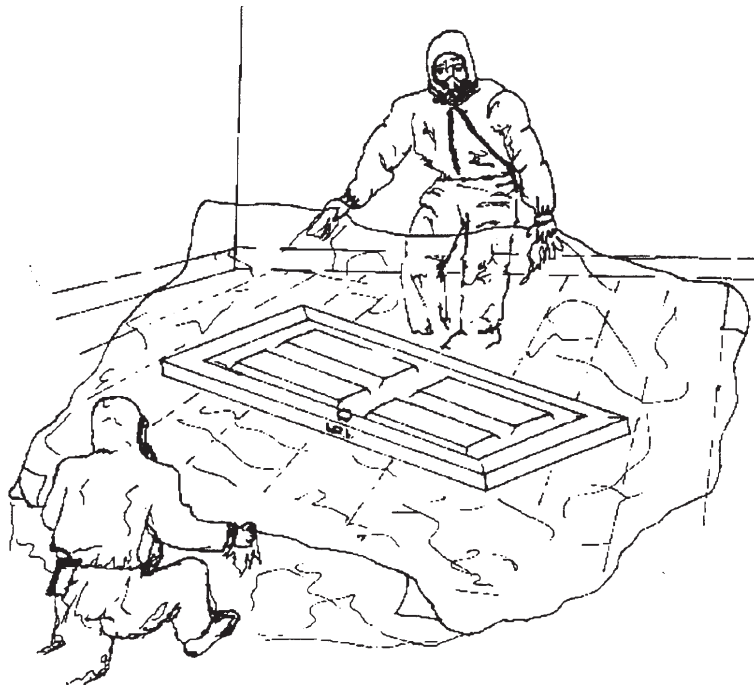

Wrap large debris in 6-mil poly.

Clean up the work site every day.

Wrap large debris in poly.



2. Wet mop the floor. Bag and label small debris.

Mist dust and small debris with water. Wet mop or wet sweep it all up. **Do not dry sweep!** This stirs up lead dust. Put the debris into 6-mil plastic bags and seal the bags. Bag, tape, and throw away the mopheads with the debris. Put labels on the bags that say “LEAD CONTAMINATED.” Store waste in a secure area until it can be tested and disposed of properly.

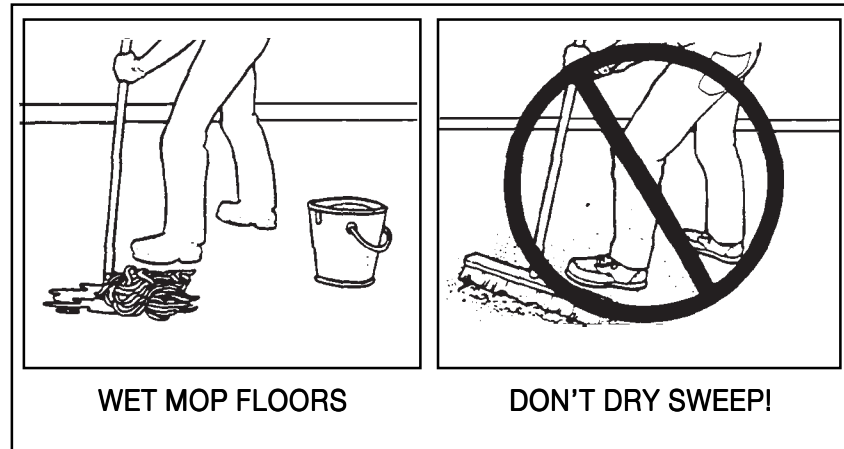

Wet mop the floors.

Do not dry sweep!

HEPA vacuum all surfaces at the end of each day.

3. HEPA vacuum all surfaces in the work area.

The OSHA Lead Standard says that you should not allow lead dust to build up. It says wherever possible use the HEPA vacuum. **Do not use a regular shop vacuum**—it cannot filter lead dust. Start at the far end of the work area and move towards the exit through the decontamination area.

4. Check poly and repair any tears or rips.

Check for tears in the poly throughout the day. Repair any rips as you find them. At the end of each day, inspect the whole containment for holes, rips, and tears in the poly. Make sure you check the poly covering the air vents and heat registers.



Final cleanup

The cleanup done at the end of the abatement job is called **final cleanup**. Final cleanup must be done slowly and carefully. Final cleanup might even take longer than the abatement itself. **There are three stages of final cleanup.** Each stage is very important and must be done thoroughly.

Many abatement jobs fail the final inspection because the final cleanup was not done properly. If an abatement job fails, you will have to do cleanup over again as many times as it takes for the job to pass. Redoing cleanup is expensive and takes a lot of work time. It is better to do it right the first time.

Wait at least one hour after you finish the abatement before you start final cleanup (even longer [e.g. overnight] if it's practical). (Check with your state and local laws.) This allows the lead dust that is in the air to settle. The time that it takes for the lead dust to settle depends on the type of work methods you used. Dust may settle onto surfaces within a few hours of encapsulation or enclosure. Smaller particles created with a needle gun or heat gun will take much longer to settle out of the air.

Stage 1: Special cleaning

1. Wear protective gear.

Put on plastic gloves to protect your hands from the lead cleaner. Wear protective goggles or other eye gear to shield your eyes. You will also wear your respirator, disposable suit, and booties or rubber boots.

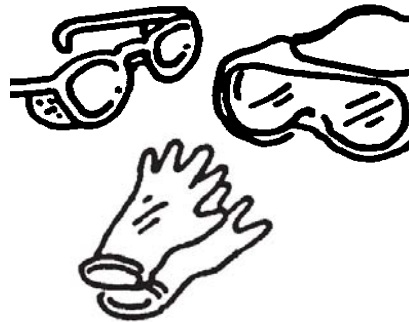

2. HEPA vacuum all surfaces.

HEPA vacuum **all surfaces** in the work area, including areas that had been covered with plastic.

Start at the far end and then work towards the decontamination area. Begin with ceilings or the top of the walls and work down, cleaning the floors last. Do every inch of the windows, especially the troughs. Use the corner tool to clean where the floor meets the baseboard and all cracks in the floor boards. Use the brush tool for the walls. Move slowly and carefully to get all the dust.

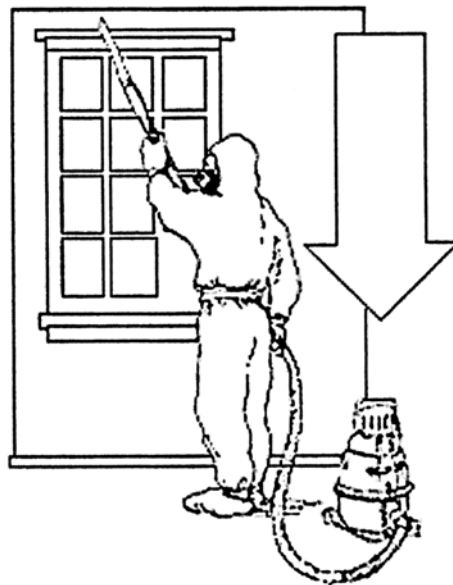

Every step in final cleanup is very important.

Final cleanup may take longer than the abatement.

For all surfaces in the work area:

- HEPA vacuum;
- wash with cleaner;
- HEPA vacuum again.



Don't remove the first layer of poly until all other poly has been removed.

3. Collect waste in sealed plastic bags or wrap in poly.

Place any remaining disposable items in 6-mil plastic bags and tie the bags shut. If waste items are too large, wrap them in 6-mil poly. Seal them with duct tape. Put labels on them that say "LEAD CONTAMINATED."

4. Wet mop and bag dust.

Use the spray bottle to wet down all dust and debris with a fine mist of water. This will help control the dust during cleanup. Wet mop the entire work area. Bag and seal the debris. Label the waste "LEAD CONTAMINATED."

5. Take off first layer of poly.

If you did not do any demolition or replacement, you may have used only one layer. If so, do *not* remove that layer, and skip to step #6.

If you used two layers of poly, now is the time to remove only the first layer. Wet mist the poly before removing it. This contaminated plastic must be removed carefully. Remove the upper plastic that covers cabinets and counters first. Then carefully remove the poly on the floor. Do not remove floor poly until all other poly has been removed. Fold top layer of poly onto itself from the edges into the center in order to trap any remaining dust inside. Seal with duct tape and put into plastic bags for disposal.

6. Wash all surfaces with cleaner.

Wash *all surfaces* in the work area with an all-purpose cleaner or a cleaner made just for lead cleanup, including areas that had been covered with plastic. Some wallpaper should only be HEPA vacuumed and not washed.

Use the 4-Step System you learned about in Chapter 5.

Start from the top and work down. Start with the ceiling and work down to the floors.

Mix up a new solution of lead cleaner often so it stays clean. Change the rinse water, rags, and mop heads at least once every 500 square feet. The number of times you must change both the wash water and the rinse water will depend on how dirty the area is. After washing each room, go back over the surfaces with a clean water rinse.

Dispose of washwater waste according to state and local laws.



Cleanup, Disposal, & Clearance



7. Remove the bottom layer of poly. Clean the floor.

After all the work above the floor has been cleaned, carefully remove the bottom layer of poly from the floor. Fold the contaminated side of the poly into itself. This will contain the lead dust and moisture. Seal the bundle with duct tape and place it in a 6-mil bag or wrap it in 6-mil poly. Label it "LEAD CONTAMINATED." HEPA vacuum the floor. Use the lead cleaner to wash it. Rinse it with clean water.

8. HEPA vacuum all surfaces again.

After all surfaces have dried, HEPA vacuum a second time. Vacuum until no dust or residue can be seen. Move slowly and carefully.

9. Collect used cleaning items in sealed plastic bags.

Discard all items used for cleaning (towels, sponges, rags, mop heads) in 6-mil plastic bags. Seal the plastic bags, making sure to "gooseneck" the opening to the bags, and label them "LEAD CONTAMINATED."

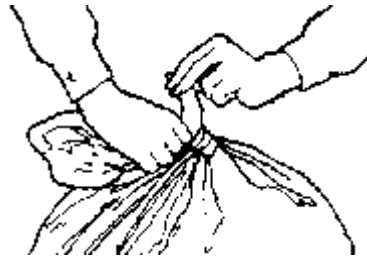

**Seal all items
used for cleaning
in plastic bags.**



Clearance Inspection

The final clearance inspection occurs in two main phases:

- visual examination
- environmental sampling

Visual examination

The work area should be visually inspected **before** you repaint or seal surfaces where the paint has been removed. The inspector will come in and look at the surfaces chosen for abatement to see if visible paint residue remains. The inspector will also look for signs of dust. This visual inspection should be done *no sooner* than one hour after cleanup is finished.

If all the abatement work is done and no dust can be seen, the job passes the visual inspection. If the job does not pass visual inspection, you will have to reclean the area until no dust can be seen.

In some states there is no requirement for visual inspection before repainting or sealing the abated surfaces, but it is often a part of the specifications. It is always a good idea to make sure you don't see any signs of lead dust before repainting an abated surface.

Stage 2: Painting and sealing

All abated surfaces should be primed with the correct type of primer for the surface. Repaint all abated surfaces. A final coat of gloss or semi-gloss is recommended. Enclosures or encapsulants may not need to be painted. Wooden floors should be sealed with clear polyurethane-based sealer or coating. Other floors such as tile or linoleum should be sealed with wax. Concrete floors need to be sealed with a concrete sealer.

Stage 3: Repeat special cleaning

Allow at least 24 hours between stage 2 and stage 3 for the paint and sealers to dry, or follow the manufacturer's specifications. Then HEPA vacuum all surfaces. Wash all surfaces with a lead cleaner (some latex paints can be damaged by cleaning solutions; use a warm water rinse instead). Then HEPA vacuum all surfaces again.



Final inspection—Environmental sampling

Once the area has been cleaned and repainted, an inspector will take dust samples for the final inspection. These samples are called clearance dust samples. Clearance dust samples are taken no sooner than one hour after final cleanup is finished. (Review Chapter 4 for more information on collecting dust samples.) The job must pass final inspection before occupants can move back into the building.

The inspector will take samples from several rooms within the work area. The inspector will sample three surfaces: floors, window sills, and window troughs. The actual number of samples will depend on

- whether there was containment (at least an airlock between the abated rooms and the rest of the dwelling or building);
- whether the abatement was done on the inside or outside of the house;
- whether the inspector does single-surface or composite dust sampling.

Common areas (such as hallways and stairwells) are also sampled. The number of samples taken in common areas depends on the size (in square feet) of the common area. **The purpose of the final inspection is to make sure that dust levels are as low as they can be.**

Clearance dust levels

The lead dust levels from these samples must be acceptable for clearance. Passing clearance means that the area has been cleaned adequately. Remember, lead in dust is measured in micrograms (μg) of lead per square foot (ft^2) of area tested.

EPA Clearance Levels

Surface	Level of lead in dust
Floors	40 $\mu\text{g}/\text{ft}^2$
Window sills	250 $\mu\text{g}/\text{ft}^2$
Window troughs	400 $\mu\text{g}/\text{ft}^2$

If the dust sample results are below these levels, then the job passes final inspection. If they are at or above these levels, you will have to redo cleanup. You will have to redo cleanup as many times as it takes for the job to pass the final clearance inspection.

The job must pass final inspection.

The final inspection makes sure that dust levels are as low as they can be.

If lead dust levels are too high, you must redo cleanup.

Dust tests show if cleanup was adequate.



Children have been poisoned after abatement jobs because cleanup was not done well.

Why measure lead in house dust?

All abatement methods create lead dust. Dust tests show if dangerous levels of lead dust still exist in a home. Lead dust is a major source of lead exposure for young children. **Children have been poisoned after abatement jobs because cleanup was not done well.** If lead dust gets left behind, the families who return to their homes or children who return to the child-occupied facility (for example, a daycare center) can be poisoned. This is why cleanup is so important. This is why passing final inspection is so important.

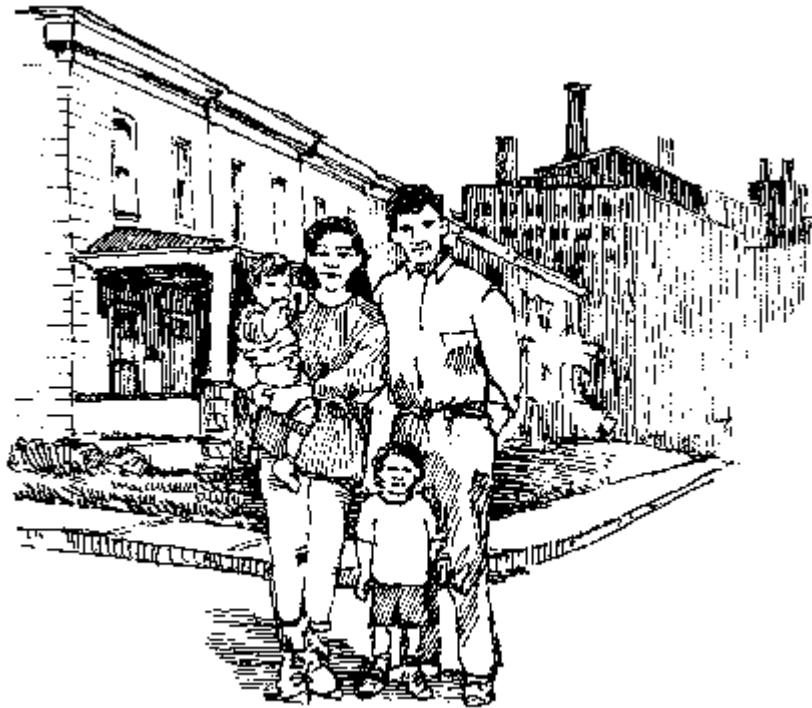

Protect the families whose homes you work on.

Do cleanup right!!



Waste from a lead abatement job

There are many waste materials from lead abatement jobs:

- lead-based paint chips
- lead-based paint dust
- large components that were removed (windows, doors, etc.)
- poly and duct tape
- sludge from paint removers
- solvents from paint stripping
- liquid waste (from cleanup, neutralizing surfaces, water blasting)
- used cleaning supplies
- disposable work clothes and respirator filters

Before the project begins, your employer must find out the federal, state, and local rules on how to dispose of each type of waste likely to be created. The building owner will need to know that all of the waste was disposed of legally.

In July 2000, EPA issued a memorandum clarifying how waste generated as a result of lead-based paint activities should be handled (*Regulatory Status of Waste Generated by Contractors and Residents from Lead-Based Paint Activities Conducted in Households*). A copy of the memo is included as Addendum A of this chapter.

What is the purpose of this interpretation?

This memorandum clarifies the regulatory status of waste generated as a result of lead-based paint activities (including abatement, renovation, and remodeling) in homes and other residences.

Since 1980, EPA has excluded “household waste” from the universe of RCRA hazardous wastes under 40 CFR 261.4(b)(1). In the 1998 temporary toxicity characteristic (TC) suspension proposal, EPA explained that the household waste exclusion applies to all lead-based paint waste generated as a result of actions by residents of households to renovate, remodel or abate their homes on their own. In the 2000 memorandum, EPA stated that they believe lead paint debris generated by contractors in households is also “household waste” and thus excluded from the RCRA Subtitle C hazardous waste regulations. Thus, the household exclusion applies to waste generated by either residents or contractors conducting lead-based paint activities in residences.

Residents and contractors managing lead-based paint waste from households, although excluded from the hazardous waste regulations, should take common sense measures to

- minimize the generation of lead dust,
- limit access to stored lead-based paint wastes including debris, and
- maintain the integrity of waste packaging material when moving or transporting the lead-based paint waste.

Separate each type of waste on the job.

Your employer must check with the state, locality, or tribe to see how they regulate LBP abatement waste.



Follow best management practices when handling and disposing of LBP waste.

In particular, EPA endorses the basic steps outlined in the 1998 proposals for the proper handling and disposal of lead-based paint waste as the best management practices (BMPs). These include:

- Collect paint chips, dust, and dirt and rubble in plastic trash bags for disposal.
- Store larger lead-based paint architectural debris pieces in containers until ready for disposal (wrap in poly before storing).
- Consider using a covered mobile dumpster (such as a roll-off container) to store lead-based paint debris until the job is done.
- Contact local municipalities or county solid waste offices to determine where and how lead-based paint debris can be disposed.

In addition, contractors working in residential dwellings are subject to either one or both of the following:

- The HUD guidance for contractors doing publicly-funded rehabilitation/renovation projects in public housing.
- EPA (or state or tribal) training and certification requirements and the proposed EPA onsite management standards.

These best management practices for households are similar to those included in the HUD *Guidelines* for individuals controlling lead-based paint hazards in housing. HUD requires that contractors using HUD funding follow the lead-based paint hazard control guidelines. Not following these guidelines can potentially result in the loss of funding.

Contractors should contact their state, local and/or tribal government to determine whether any restrictions apply to the disposal of residential lead-based paint waste. **This verification is necessary since, under RCRA, States, local and tribal governments can enforce regulations that are more stringent or broader in scope than the federal EPA requirements.** In those cases, lead-based paint waste from households may still be regulated as a hazardous waste as matter of State regulations. In states or tribes that do not have an exemption for residential lead abatement waste and for commercial (nonresidential) structures, the following information applies.

State, localities, and Indian Tribes may *not* have an exemption for residential LBP waste.



Handling waste on the job

Your employer is responsible for determining what types of waste and how much waste is generated on an abatement project.

If the state, tribe, or city in which you are working treats lead abatement waste as possibly hazardous and if your job is creating more than 220 pounds of waste per month, your employer will need to take a small sample from each type of waste and have it tested. If your employer is creating less than 220 pounds of waste per month, you may be able to dispose of the waste as nonhazardous waste **after** checking with the state and solid waste disposal facility. Dispose of the waste according to state and local laws.

Separate each type of waste on a job. Your employer or supervisor will take a sample from each type of waste to see if it is hazardous. Hazardous waste is waste that can poison people and the environment if it is not handled carefully. Your supervisor or employer is responsible for telling you what waste is hazardous and what is nonhazardous. **All waste should be kept within the contained area on the job until it is tested to determine if it is hazardous.** Even if the waste you create is nonhazardous, it may still pose an exposure hazard to you and to the occupants.

Warning! Sometimes regulations call all waste “solid waste” until it is tested. Sometimes the regulations call all nonhazardous waste “solid waste,” including nonhazardous liquid waste. **In this manual, “solid waste” means solid material and “liquid waste” means liquid material.**

Your employer is responsible for determining what types of waste are generated on the project.



Do not pour liquid waste down a drain or onto the ground.

Liquid waste

The contract specifications for larger jobs will often tell your supervisor how to handle liquid waste. On small jobs you may not have any specifications. Liquid waste includes wash water from cleanup, the neutralizing solution used for paint strippers, and waste from water blasting. Liquid waste should be filtered before disposal to remove as much of the lead and other particles as possible. Store liquid waste in noncorrosive containers.

Contact the local sewage treatment center and the state department of the environment for directions on how to dispose of liquid waste properly. Never pour it down toilets, drains, storm sewers, or onto the ground. (Note: In some cases, liquid debris from dust abatement or renovation/remodeling **may** be disposed of down the toilet. You should check with the state or local waste water agencies to check before doing so.)

Liquid waste from lead abatement is often hazardous waste. It must be treated by a liquid waste treatment facility before disposal. If you are generating lots of liquid waste, store the waste in 55-gallon steel or plastic drums until it is tested.



Testing and disposing of waste

If you are working in a state/area where local regulations require that lead abatement wastes be treated as hazardous, all waste from lead abatement jobs must be tested to see if it is hazardous waste. Hazardous waste is liquid or solid waste that could poison people if it is not disposed of correctly.

Your employer will test different types of waste to see if they are hazardous. This is done with a special test called a “Toxicity Characteristic Leachate Procedure” test. This test is often called a “TCLP” test. The TCLP test looks at how the waste material will break down. It checks to see if the waste material will leak or release a hazard.

Lead waste—including paint chips, sludge from chemical strippers, and water from water blasting—are some of the types of waste that must be tested. Once your employer has tested the waste, you will be responsible for keeping the hazardous and nonhazardous wastes separated.

Your employer may have to take a sample of each type of waste to see if it is hazardous.



Use a secure space to store wastes.

Never burn lead waste!

Nonhazardous waste disposal

These steps are appropriate for all waste if you are working in a state which follows EPA guidance stating that lead abatement waste from residential structures is exempt from hazardous waste requirements.

1. Bag or wrap solid waste in 6-mil poly.

Seal with duct tape. Do this as part of cleanup every day and at the end of the job. Do not use a bag labelled "asbestos" when you are bagging lead. Label the bag "LEAD CONTAMINATED."

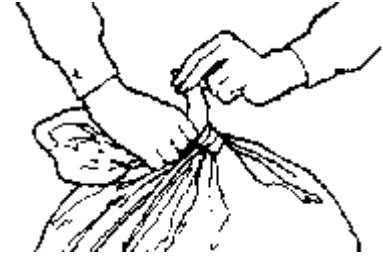

2. Store waste in a secure space.

Store waste in an area closed off to people other than workers. Protect waste from children, animals, the weather, and anything else that can disturb it. Sometimes you can use a locked dumpster. Put signs that say "DANGER! CONTAINS LEAD WASTE" on the storage space.

3. Take waste to a landfill in a covered vehicle.

Transport solid waste to a municipal or lined landfill (your employer should check to determine what your state or local laws require). Always transport waste from a lead-abatement job in a covered truck. This keeps lead dust from getting into the environment.

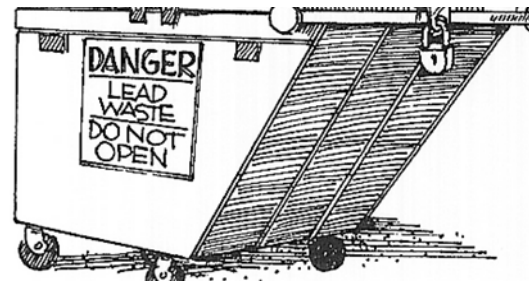

WARNING: Do not take waste from a lead-abatement job to an incinerator. Burning lead waste creates lead fumes that get into the air. Lead fumes are very easy to inhale and are very dangerous to health.



Hazardous waste disposal

If the state, tribe, or city in which you are working treats lead abatement waste as possibly hazardous, avoid abatement methods which generate hazardous waste, such as chemical stripping. If you use such methods, your employer must plan how to contain, transport, and dispose of the hazardous waste before the project begins. Hazardous waste is much more expensive to dispose of than nonhazardous waste.

The federal law that covers hazardous waste is the **Resource Conservation and Recovery Act**. It is called **RCRA** for short.

If your employer or supervisor has determined that some or all of the waste you are handling is hazardous, then he or she must have you do the following:

1. Store all hazardous waste in special containers.

Store hazardous waste in 55-gallon drums, tanks, or other containers that match the type of waste. The Department of Transportation or state waste management agency will give you the information you need to choose the right container. All containers must be marked "HAZARDOUS WASTE" in bright red and yellow colors. All containers must have a label that lists their contents.

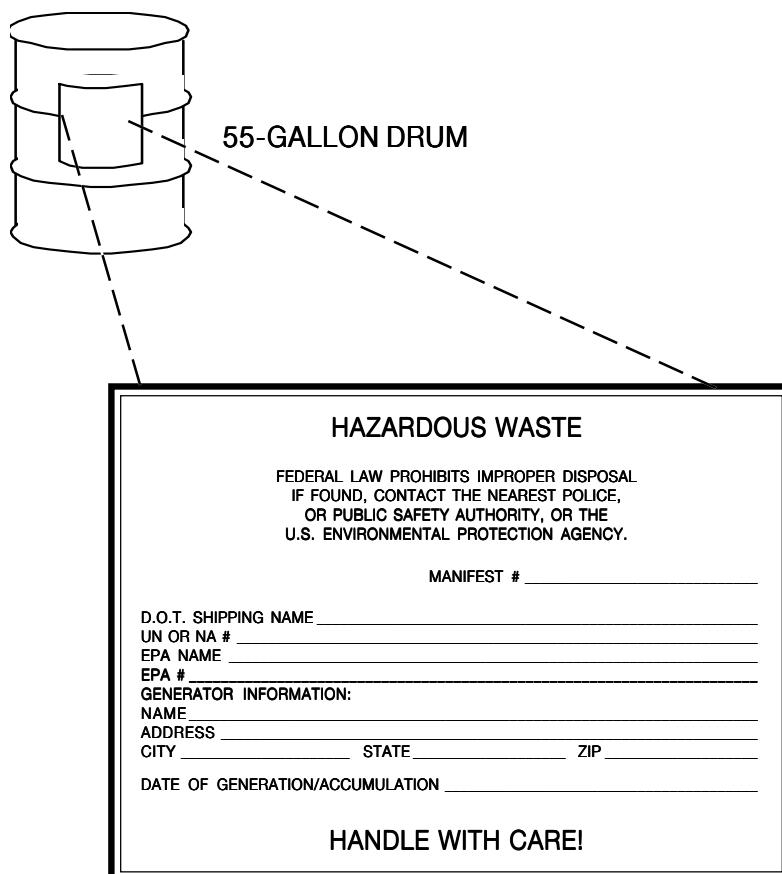

Hazardous waste is dangerous to human health and the environment.

Store hazardous waste in special containers.

Label the containers.



Hazardous waste must go to a licensed disposal site.

2. Store hazardous waste in a secure area.

Store waste in an area closed off to people other than workers. Protect waste from anything else that can disturb it. Regularly inspect containers for leaks or corrosion. Hazardous waste can be stored at the company's facility for up to 90 days.

3. Use a licensed transporter.

The person or company that transports hazardous waste must be approved by the EPA. Be careful when you move hazardous waste containers. Use hand trucks, dollies, pull carts, and ramps whenever you can. This will help prevent containers from breaking and help protect everyone from exposure to hazardous waste.

4. The hazardous waste must be brought to a licensed disposal site.

The transporter must take the hazardous waste to a disposal facility that is licensed to accept this type of hazardous waste. The site must be approved by EPA. All hazardous waste must be disposed of within 90-180 days of the start of collection.

5. Use a Hazardous Waste Manifest.

An EPA form called a "**Hazardous Waste Manifest**" must be with every shipment. Your employer or supervisor, the transporter, and the receiver at the disposal site must all sign the manifest.

Other requirements:

Some contractors have to follow even more requirements for hazardous waste. They include contractors who

- generate more than 2,200 pounds of hazardous waste per month;
- abate more than one housing unit at a time;
- abate commercial, public, and industrial buildings.



EPA studies of paint abatement waste

EPA sponsored two studies of lead abatement waste. They used jobs from the HUD demonstration project in 1991.

After the first study, EPA found that certain types of waste generally were hazardous or not hazardous. For some kinds of waste they did not have enough data to draw conclusions. So, they did a second study.

The results from the second study are in the following chart. These results only give you an idea of what might happen on your project. You can separate the waste into these two groups before the TCLP tests are done. The following results from the second study are not conclusive.

Current federal EPA guidance does not require TCLP testing of lead abatement wastes. However, some states, tribes, or localities may require that any contractor generating more than 220 pounds of waste per month sort and test waste from each project or use knowledge from prior similar projects. Local and state or tribal regulations may require that even waste from small jobs be tested.

ABATEMENT WASTE

Hazardous	Usually not hazardous
<ul style="list-style-type: none">• Paint chips• Paint dust (from HEPA vacuums and air filters)• Rags, sponges, mops, HEPA filters, other cleaning materials• Air monitoring cartridges• Scrapers• Unfiltered wash water• Solid waste with lead level higher than 4 mg/cm²• Poly and tape from jobs where heat guns used	<ul style="list-style-type: none">• Filtered wash water• Disposable work clothes and respirator filters (HEPA vacuumed before disposal)• Solid waste, such as window frames, with lead level less than 4 mg/cm² (measured at lab)• Poly and tape from encapsulation and enclosure jobs (HEPA vacuumed before disposal)

Tests results from previous similar jobs may be used to determine if waste is hazardous or not.



Key facts for Chapter 8

 Cleanup is the most important part of the abatement job.

Cleanup must be done slowly and thoroughly.

It may take longer than doing the abatement.

 **Daily cleanup**

1. Wrap large debris in poly.
2. Wet mop or wet sweep small debris and bag it.
3. Check the poly and repair any tears or rips.
4. HEPA vacuum all surfaces.

 **Wait one hour after finishing abatement before you begin final clean up.**
(Check your state and local laws)

 **Final cleanup must be done slowly and thoroughly**

 **Final cleanup—Stage 1**

Every step of final cleanup is important:

1. Wear protective clothing, including a respirator and goggles.
2. Wet mop the entire area and bag all dust.
3. Take up the first layer of poly.
4. HEPA vacuum all surfaces.
5. Wash all surfaces with a cleaning solution and then rinse. Follow state and local laws about disposal of wash water.
6. HEPA vacuum all surfaces again.
7. Dispose of all cleaning items in sealed 6-mil plastic bags.

Some states require a visual inspection of the abatement job after the first stage of final cleanup. Wait one hour after finishing final cleanup before letting the inspector go in.

 **Final cleanup—Stage 2**

Paint and seal all the abated surfaces.

 **Final cleanup—Stage 3**

HEPA vacuum all surfaces. Wash all surfaces with a cleaning solution and rinse well. HEPA vacuum all surfaces again.



Clearance inspection

Two phases: visual inspection and environmental sampling.

Do this no sooner than one hour after final cleanup is done.

Every lead abatement job must pass a final inspection.

Dust wipe tests measure the amount of lead in the house.

If lead dust levels are too high, you must redo cleanup.

EPA allows states and tribes to treat lead-based paint abatement waste as nonhazardous waste.

Your employer must check with the state or tribe in which the job is being done to determine whether any restrictions apply to the disposal of residential lead-based paint waste.

Waste from a lead abatement job

-  1. Store waste in a locked place until it can be disposed of.
2. Waste should not be removed from the contained area on the job site until your employer knows if it is hazardous or not.
3. Liquid waste should be filtered before disposal.
4. Hazardous waste can be stored for a limited time (depending on your employer's generator status) at the company's facility.

Handling nonhazardous waste

Wrap or bag solid waste in 6-mil poly.

Label waste "Lead-Contaminated."

Transport solid waste to a lined dump in a covered truck.

Never burn lead waste.

Do not pour liquid waste down a drain, storm sewer, or onto the ground.

Handling hazardous waste

Store hazardous waste in special, labelled containers.

Use a licensed transporter to take the hazardous waste away.

Hazardous waste must go to a licensed disposal site.

A manifest must go with every shipment of hazardous waste.



For more information

These publications have more information on the topics covered in this chapter. Your instructor has a copy of the publications marked with a star (*). You can order your own copies by calling 1-800-424-LEAD.

*EPA, *Lead: Identification of Dangerous Levels of Lead; Final Rule*; 40 CFR Part 745 (January 2001).

*EPA, *Regulatory Status of Waste Generated by Contractors and Residents from Lead-Based Paint Activities Conducted in Households*, Interpretive Memorandum (July 2000).

EPA, *Temporary Suspension of Toxicity Characteristic Rule for Specified Lead-Based Paint Debris*; 40 CFR Part 745, Subpart P (December 1998).

*HUD, *Guidelines for the Evaluation and Control of Lead-Based Paint Hazards in Housing* (June 1995).

RCRA Hotline for information on waste disposal: 1-800-424-9346.



Addendum A

EPA Memorandum:
Regulatory Status of Waste Generated by Contractors and
Residents from Lead-Based Paint Activities Conducted in
Households

**MEMORANDUM**

From: Elizabeth A. Cotsworth, Director
Office of Solid Waste

To: RCRA Senior Policy Advisors
EPA Regions 1 - 10

Subject: Regulatory Status of Waste Generated by Contractors and Residents from Lead-Based Paint Activities Conducted in Households

What is the purpose of this interpretation?

This memorandum clarifies the regulatory status of waste generated as a result of lead-based paint (LBP) activities (including abatement, renovation and remodeling) in homes and other residences. Since 1980, EPA has excluded "household waste" from the universe of RCRA hazardous wastes under 40 CFR 261.4(b)(1). In the 1998 temporary toxicity characteristic (TC) suspension proposal, we clarified that the household waste exclusion applies to all LBP waste generated as a result of actions by residents of households (hereinafter referred to as "residents") to renovate, remodel or abate their homes on their own. (At 63 FR 70233, 70241, Dec. 18, 1998). In this memorandum, EPA is explaining that we believe lead paint debris generated by contractors in households is also "household waste" and thus excluded from the RCRA Subtitle C hazardous waste regulations. Thus, the household exclusion applies to waste generated by either residents or contractors conducting LBP activities in residences.

What is the practical significance of classifying LBP waste as a household waste?

As a result of this clarification, contractors may dispose of hazardous-LBP wastes from residential lead paint abatements as household garbage subject to applicable State regulations. This practice will simplify many lead abatement activities and reduce their costs. In this way, the clarification in today's memorandum will facilitate additional residential abatement, renovation and remodeling, and rehabilitation activities, thus protecting children from continued exposure to lead paint in homes and making residential dwellings lead safe for children and adults.

LBP debris (such as architectural building components — doors, window frames, painted wood work) that do not exhibit the TC for lead need not be managed as hazardous waste. However, LBP waste such as debris, paint chips, dust, and sludges generated from abatement and deleading activities that exhibit the TC for lead (that is, exceed the TC regulatory limit of 5 mg/L lead in the waste leachate), are hazardous wastes and must be managed and disposed of in accordance with the applicable RCRA subtitle C requirements (including land disposal restrictions) except when it is "household waste." Under 40 CFR 261.4(b)(1), household wastes are excluded from



the hazardous waste management requirements. Today, EPA is clarifying that waste generated as part of LBP activities conducted at residences (which include single family homes, apartment buildings, public housing, and military barracks) is also household waste, that such wastes are no longer hazardous wastes and that such wastes thus are excluded from RCRA's hazardous waste management and disposal regulations. Generators of residential LBP waste do not have to make a RCRA hazardous waste determination. This interpretation holds regardless of whether the waste exhibits the toxicity characteristic or whether the LBP activities were performed by the residents themselves or by a contractor.

Where can I dispose of my household LBP waste?

LBP waste from residences can be discarded in a municipal solid waste landfill (MSWLF) or a municipal solid waste combustor. Dumping and open burning of residential LBP waste is not allowed. Certain LBP waste (such as large quantities of concentrated lead paint waste—paint chips, dust, or sludges) from residential deleading activities may be subject to more stringent requirements of State, local, and/or tribal authorities.

What is the basis for this interpretation?

The household waste exclusion implements Congress's intent that the hazardous waste regulations are "not to be used either to control the disposal of substances used in households or to extend control over general municipal wastes based on the presence of such substances." S. Rep. No. 94-988, 94th Cong., 2nd Sess., at 16. EPA regulations define "household waste" to include "any waste material (including garbage, trash, and sanitary wastes in septic tanks) derived from households (including single and multiple residences, hotels and motels, bunkhouses, ranger stations, crew quarters, campgrounds, picnic grounds and day-use recreation areas)." 40 CFR 261.4(b)(1). The Agency has applied two criteria to define the scope of the exclusion: (1) the waste must be generated by individuals on the premises of a household, and (2) the waste must be composed primarily of materials found in the wastes generated by consumers in their homes (49 FR 44978 and 63 FR 70241).

In 1998, EPA concluded that LBP waste resulting from renovation and remodeling efforts by residents of households met these criteria. (63 FR 70241-42, Dec. 18, 1998). In short, the Agency found that more and more residents are engaged in these activities and thus the waste can be considered to be generated by individuals in a household and of the type that consumers generate routinely in their homes. Wastes from LBP abatements performed by residents were also considered household wastes.

EPA clarifies that this interpretation also applies to contractor-generated LBP waste from renovations, remodeling and abatements in residences. Both the definition of household waste in section 261.4(b)(1) and the Agency's criteria for determining the scope of the exclusion focus on the type of waste generated and the place of generation



rather than who generated the waste (e.g., a resident or a contractor). This approach is consistent with prior Agency policy.¹ Since contractor-generated LBP waste from residential renovations, remodeling, rehabilitation, and abatements are of the type generated by consumers in their homes, it is appropriate to conclude that such waste, whether generated by a resident or contractor, falls within the household waste exclusion. This clarification will facilitate lead abatements and deleading activities in target housing by reducing the costs of managing and disposing of LBP waste from residences.

What is the relationship of this interpretation to the on-going LBP debris rulemaking?

On December 18, 1998, EPA proposed new TSCA standards for management and disposal of LBP debris (63 FR 70190) and simultaneously proposed to suspend temporarily the applicability of the RCRA hazardous waste regulations that currently apply to LBP debris (63 FR 70233). This memorandum responds to stakeholders requests that EPA clarify whether the existing household waste exclusion applies to both homeowners and contractors conducting LBP activities in residences. While the Agency still intends to finalize aspects of the two proposals, we are making this clarification in advance of the final rule to facilitate LBP abatement in residences without unnecessary delay.

How does this interpretation affect EPA's enforcement authorities?

Under this clarification, LBP wastes generated by residents or contractors from the renovation, remodeling, rehabilitation, and/or abatement of residences are household wastes that are excluded from EPA's hazardous waste requirements in 40 CFR Parts 124, and 262 through 271. The household waste provision of 40 CFR 261.4(b)(1) only excludes such wastes from the RCRA regulatory requirements. However, it does not affect EPA's ability to reach those wastes under its statutory authorities, such as RCRA §3007 (inspection) and §7003 (imminent hazard). See 40 CFR §261.1(b).

¹ In the final rule establishing standards for the tracking and management of medical waste, EPA concluded that waste generated by health care providers (e.g., contractors) in private homes would be covered by the household waste exclusion (54 FR 12326, 12339, March 24, 1989). In the specific context of LBP, the Agency stated in a March 1990 "EPA Hotline Report" (RCRA Question 6) that lead paint chips and dust resulting from stripping and re-painting of residential walls by homeowner or contractors (as part of routine household maintenance) would be part of the household waste stream and not subject to RCRA Subtitle C regulations. Similarly, in a March 1995 memorandum on the "Applicability of the Household Waste Exclusion to Lead-Contaminated Soils," we found that if the source of the lead contamination was as a result of either routine residential maintenance or the weathering or chalking of lead-based paint from the residence, the hazardous waste regulations do not apply so long as the lead-contaminated soil is managed onsite or disposed offsite according to applicable solid waste regulations and/or state law mandated by RCRA.



What are the "best management practices" for handling residential LBP waste?

Although excluded from the hazardous waste regulations, EPA encourages residents and contractors managing LBP waste from households to take common sense measures to minimize the generation of lead dust, limit access to stored LBP wastes including debris, and maintain the integrity of waste packaging material during transfer of LBP waste. In particular, we continue to endorse the basic steps outlined in the 1998 proposals for the proper handling and disposal of LBP waste (63 FR 70242) as the best management practices (BMPs) including:

- Collect paint chips and dust, and dirt and rubble in plastic trash bags for disposal.
- Store larger LBP architectural debris pieces in containers until ready for disposal.
- Consider using a covered mobile dumpster (such as a roll-off container) for storage of LBP debris until the job is done.
- Contact local municipalities or county solid waste offices to determine where and how LBP debris can be disposed.

In addition, contractors working in residential dwellings are subject to either one or both of the following:

- The HUD Guidance for contractors doing publicly-funded rehabilitation/ renovation projects in public housing. (See *Guidelines for the Evaluation and Control of Lead-Based Paint Hazards in Housing*. U.S. Department of Housing and Urban Development, June 1995.) The HUD *Guidelines* can be accessed via the Internet at: <http://www.hud.gov/office/lead>
- TSCA 402/404 training and certification requirements. (See 40 CFR Part 745; 61 FR 45778, August 29, 1996) and the proposed TSCA onsite management standards (See 40 CFR Part 745, Subpart P; 63 FR 70227 - 70230, Dec. 18, 1998). [EPA expects to issue the final rule next year.]

The above-mentioned BMPs for households are similar to those included in the HUD Guidelines for individuals controlling LBP hazards in housing. HUD requires that contractors using HUD funding adhere to LBP hazard control guidelines. Non-adherence to these guidelines can potentially result in the loss of funding.

Does this interpretation apply in my State and/or locality?

We encourage contractors and residents to contact their state, local and/or tribal government to determine whether any restrictions apply to the disposal of residential LBP waste. This verification is necessary since, under RCRA, States, local and tribal governments can enforce regulations that are more stringent or broader in scope than the federal requirements. Thus, under such circumstances, LBP waste from households may still be regulated as a hazardous waste as a matter of State regulations.



We are distributing this memorandum to all 56 States and Territories, and Tribal Programs and various trade associations. We encourage States to arrange for implementation of the interpretation discussed in this memo in their States to facilitate residential LBP abatements making residential dwellings lead-safe. We encourage trade associations to inform their memberships about this memo and instruct them about ways to manage residential LBP waste.

Whom should I contact for more information?

If you have additional questions concerning the regulatory status of waste generated from lead-based paint activities in residences, please contact Ms. Rajani D. Joglekar of my staff at 703/308-8806 or Mr. Malcolm Woolf of the EPA General Counsel's Office at 202/564-5526.

cc: Key RCRA Contacts, Regions 1 - 10

RCRA Regional Council Contacts, Regions 1 - 10

RCRA Enforcement Council Contacts, Regions 1 - 10

Association of State and Territorial Solid Waste Management Officials
(ASTSWMO)



CHAPTER 9

SOIL ABATEMENT AND EXTERIOR DUST CLEANUP

Learning objectives	9-3
Soil abatement and exterior dust cleanup	9-4
Soil-lead hazards	9-4
Soil abatement	9-5
Exterior dust cleanup	9-7
Key facts for Chapter 9	9-8
For more information	9-9





Learning objectives

In this chapter you will learn

- why lead in soil is a health hazard
- what levels of lead in residential bare soil are considered hazards
- how lead exposure from soil can be controlled



Removal and replacement of soil can be expensive.

Interim controls for soil-lead hazards include planting grass, laying sod, or using mulch.

A soil-lead hazard in bare soil is:

- 400 ppm in a play area;
- average of 1,200 ppm in the rest of the yard.

Soil abatement and exterior dust cleanup

Bare soil with high lead levels is a major health hazard, especially to children. Lead-contaminated soil could be a hazard because children may play in or near it, and dirt tracked into a home can lead to increased lead dust levels in the home. Government agencies used to recommend removing and replacing six to 24 inches of soil that contained high lead levels. However, studies have shown this process to be very costly and not to be a very effective way to reduce the blood lead levels of children living in these areas. Often, the best approach is to remove two to three inches, and then test the new lead levels of remaining soil. If the levels of lead are still high, more soil may need to be removed. Some states require abated soil to be tested to see if it is a hazardous waste.

If the soil has low levels of lead, the best method is to reduce access to the bare soil. This can be done by planting grass, laying sod, or covering the area with mulch. Activities such as these are called interim controls, because they are temporary methods of minimizing exposure to the lead in the soil.

Gardens grown in soil contaminated with lead can also be a health risk. Leafy vegetables and vegetables that grow under ground (such as carrots and potatoes) can absorb lead. These vegetables can then be eaten by people.

Soil abatement and exterior dust cleanup are considered together because they will likely occur together in abatement projects. Since soil abatement will tend to contaminate immediately adjacent paved areas, these paved areas should then be cleaned.

Soil-lead hazards

A soil-lead hazard is present in bare residential soil:

- in a play area when the soil-lead concentration is equal to or greater than 400 parts per million;
- from the rest of the yard (i.e., non-play areas) when the average soil-lead concentration of samples collected is equal to or greater than 1,200 parts per million.

It is important to remember that your state/Indian tribe may establish different levels of lead in soil which are considered a soil-lead hazard. Your supervisor or employer is responsible for following the applicable standards!



Soil abatement

Lead-contaminated soil in residential areas can be treated in two main ways:

- abatement by
 - removing and replacing the contaminated soil with clean soil, or
 - permanently covering the contaminated soil with concrete or asphalt;
- interim controls such as
 - covering with several inches of clean soil or mulch, or planting sod or grass.

The depth of soil removed during an abatement project is an important issue. In projects where there are extremely hazardous materials or chemicals which may contaminate the ground water, all contaminated soil is generally removed or physically isolated at the site. Soil contaminated with less hazardous materials, such as lead from lead-based paint, may either be removed or partially removed and topped with “clean” soil.

Removal and replacement is the most common abatement strategy for lead-contaminated soil. Before beginning a soil removal project, make sure your supervisor has shown you where any buried utility lines are located. Your employer is required to find out if and where any buried cable, telephone, water, or electrical lines are located *before* you start digging.

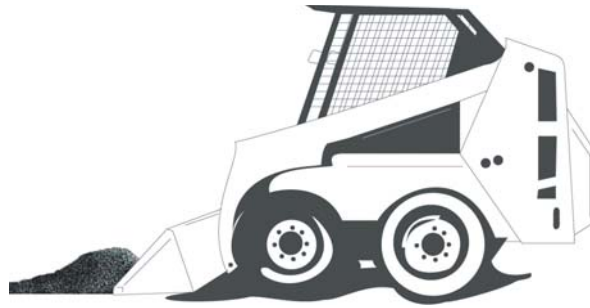

Removal and replacement of soil in residential abatement situations may involve working in both large and small sites. Some urban yards are very small, consisting of only a few square yards in some cases. Other urban yards are larger but they are sometimes surrounded by buildings. Because of this, residential soil abatement will often require extensive hand labor in addition to mechanical soil removal. When soil is removed by hand, it can be loaded into wheelbarrows. The soil in the wheelbarrows must then be taken to other vehicles to be transported to the disposal site.





Contaminated soil removed from a soil abatement project cannot be used as top soil at another residential property or child-occupied facility!

EPA requires that if soil removal and replacement is done, then the replacement soil must have a lead concentration as close to the local soil background levels as possible, but cannot be more than 400 ppm lead. The soil that is removed cannot be used as top soil at another residential property or child-occupied facility. Your employer or supervisor is required to properly dispose of the contaminated soil.

Sometimes it is difficult to locate large amounts of soil with low enough levels of lead. In those situations, or in cases when removal and replacement is too costly, the lead-contaminated soil may be permanently covered by concrete or asphalt. Concrete or asphalt is an approved method of abatement for lead-contaminated soil.



Exterior dust cleanup

Exterior dust cleanup would be more likely to occur alone, whereas, soil abatement is always followed by exterior dust cleanup. It could possibly be performed for a neighborhood area as part of a cleanup after an improper lead-based paint abatement in which a neighborhood was contaminated. This could result from a contractor or owner burning, sand blasting, or dry sanding lead-based paint from a structure. It could also be performed periodically where the exterior dust was contaminated by industrial or mining-related operations.

Exterior dust cleanup is an important abatement strategy because of the amount of lead in some street dust, and because contaminated dust is considered to be the primary exposure source. Just as children can be directly exposed to soil lead, they can also be exposed to exterior dust lead. Exterior dust can enter homes in several ways. Exterior dust lead concentrations over 100,000 ppm (equal to 10 percent lead in dust) have been measured in urban areas.

Cleaning up exterior dust consists of removing as much dust and dirt as possible from all paved surfaces within the abatement area. Lead-contaminated dust can be found on paved surfaces such as streets, street gutters, sidewalks, alleys, patios, and parking lots. The paved surfaces exist in a variety of materials. Commonly used paving materials are asphalt, concrete, and paving bricks. Surfaces such as old brick-paved alleys present the biggest challenge in removing street dust.

Cleaning up exterior dust consists of removing as much dust and dirt as possible from all paved surfaces within the abatement area.



Key facts for Chapter 9

 **High levels of lead in soil can be a major health hazard, especially to children.**

Children may play in or near lead-contaminated soil and track it back into the home.

Pets can also track it into the home.

Gardens grown in lead-contaminated soil can also be a health risk.

 **Soil-lead hazard levels are set by EPA or your state or Indian tribe.**

A soil-lead hazard* is present in bare soil:

- in a play area when the soil-lead concentration is equal to or greater than 400 parts per million;
- from the rest of the yard (i.e., non-play areas) when the average of samples collected is equal to or greater than 1,200 parts per million.

* Your employer must check with the state or Indian Tribe in which the work is being done to see if they have set different soil-lead hazard levels.

 **Lead-contaminated soil in residential areas can be treated in two main ways:**

Abatement—either removal and replacement or covering the soil with concrete or asphalt.

- Replacement soil must have lead levels close to the local background levels, but not more than 400 ppm.
- Make sure all underground utilities have been marked *before* you dig!

Interim controls—laying sod, planting grass, and mulching.

 **Exterior dust cleanup is usually done after soil abatement because soil abatement typically causes surrounding concrete areas to become contaminated.**



For more information

These publications have more information on the topics covered in this chapter. Your instructor has a copy of the publications marked with a star (*). You can order your own copies by calling 1-800-424-LEAD.

*EPA, *Lead: Identification of Dangerous Levels of Lead; Final Rule*; 40 CFR Part 745 (Jan 2001).

*EPA, *Lead: Requirements for Lead-Based Paint Activities in Target Housing and Child-Occupied Facilities*; 40 CFR Part 745 (August 1996).

EPA, *Applicability of RCRA Disposal Requirements to Lead-Based Paint Abatement Wastes* (March 1993).

*HUD, *Guidelines for the Evaluation and Control of Lead-Based Paint Hazards in Housing* (June 1995).

*OSHA, *Interim Final Lead in Construction Standard*; 29 CFR 1926.62 (May 1993).





CHAPTER 10

GLOSSARY AND RESOURCES



Abatement	Any measure or set of measures designed to permanently eliminate lead-based paint hazards.
ABC-rated fire extinguisher	Fire extinguishers are rated according to the type of fire they are used on: Class A for paper and wood, Class B for more flammable materials such as liquids or greases, and Class C for electrical fires. An ABC-rated fire extinguisher puts out all of these kinds of fires. An ABC-rated fire extinguisher is recommended for work sites.
Accessible surface	An interior or exterior surface that a young child can reach—such as a window sill—to chew or put its mouth on.
Accreditation	A formal recognition that an organization, such as a laboratory, is qualified to carry out specific tasks or types of tests.
Action level	The level at which an employer must begin certain compliance activities outlined in the OSHA lead standard. The action level, regardless of respirator use, for the lead in construction standard is an airborne concentration of 30 µg/m ³ calculated as an 8-hour time-weighted average (TWA).
Acute effect	Severe or immediate reaction, usually to a single large exposure to a toxin or substance.
Adequate quality control	Means a plan or design which ensures the authenticity, integrity, and accuracy of samples, including dust, soil, and paint chip or paint film samples. Adequate quality control also includes provisions for representative sampling.
AIHA	American Industrial Hygiene Association.
Anemia	A condition where there is not enough iron in your blood. Anemia makes people very tired.
Anodic stripping voltametry (ASV)	An analytical method for identifying small amounts of metals within a substance. The charged atoms of the metal (e.g., lead) in a solution are attracted to an electric probe. After the charged atoms collect upon the probe, they are stripped off and measured.



Atomic absorption spectroscopy (AAS)	A method of measuring elements such as lead. The lead is turned into a gas at high temperatures, usually several thousand degrees, and light of a very specific wave length is passed through the vapor. The instrument measures how concentrated the lead is in the test material.
Biological monitoring	The analysis of a person's blood and/or urine to determine the level of a contaminant, such as lead, in the body.
Blank	An unused sample of the medium being used for testing (i.e., wipe or filter) that is tested to determine if the medium has been contaminated with lead (e.g., at the factory or during transport).
Blind sample	A sample submitted for analysis when the sample and its elements are known to the submitter but not to the analyst. This is done to test the laboratory analyst's accuracy and skill in analyzing samples. (See also "spiked sample").
Body burden	The total amount of a substance that is deposited in the entire body. Metal substances, such as lead and mercury, tend to accumulate in the kidneys, the liver, and especially the bones.
Building component	Any part of a building that may be painted or have dust on its surface, e.g. walls, stair treads, floors, railings, doors, window sills, etc.
Calcium	A nutrient that helps make bones strong. If you do not have enough calcium in your diet, your body will absorb more lead.
Carcinogen	A substance that can cause cancer.
Certified	Describes people who have completed training and other requirements to allow them to safely perform risk assessments, inspections, or abatement work.
Certified firm	A company, partnership, corporation, sole proprietorship, association, or other business entity that performs lead-based paint activities to which a state agency or EPA has issued a certificate of approval.



Certified inspector	An individual who has been trained by an accredited training program and certified by a state agency or by EPA to conduct inspections. A certified inspector also samples for the presence of lead in dust and soil for the purposes of clearance testing after abatement has been performed.
Certified abatement worker	An individual who has been trained by an accredited training program and certified by a state agency or by EPA to perform abatements.
Certified project designer	An individual who has been trained by an accredited training program and certified by a state agency or by EPA to prepare abatement project designs, occupant protection plans, and abatement reports.
Certified risk assessor	An individual who has been trained by an accredited training program and certified by a state agency or by EPA to conduct risk assessments. A risk assessor also samples for the presence of lead in dust and soil for the purposes of abatement clearance testing.
Certified supervisor	An individual who has been trained by an accredited training program and certified by a state agency or by EPA to supervise and conduct abatement projects, and to prepare occupant protection plans and abatement reports.
CFR—The Code of Federal Regulations	The regulations of the various federal agencies arranged into a numbered sequence for easy referral .
Chalking	The effect of light and oxygen on paint binders—usually due to weathering—that causes a powder to form on the film surface.
Characteristics	EPA has identified four characteristics of a hazardous waste: ignitable; corrosive; reactive; and toxic. Any solid waste that exhibits one or more of these characteristics is classified as a hazardous waste under RCRA.
Chelation therapy	The medical treatment in which a drug that is attracted to metals (such as lead) is infused into a patient’s vein. The drug binds to the metal in the blood, and both are passed by the kidney in urine.



Chemical stripping	The use of chemicals to strip off paint. Chemical stripping is usually done with solvents or corrosive pastes.
Chewable surface	An interior or exterior surface painted with lead-based paint that a young child can mouth or chew. A chewable surface is the same as an “accessible surface” as defined in 42 U.S.C. 4851b(2)). Hard metal substrates and other materials that cannot be dented by the bite of a young child are not considered chewable.
Child-occupied facility	A building, or portion of a building, constructed before 1978 that is visited regularly by the same child, 6 years of age or under, on at least two different days within any week (Sunday through Saturday period), provided that each day’s visit lasts at least 3 hours and the combined weekly visits total at least 6 hours, and the combined annual visits total at least 60 hours. Child-occupied facilities may include, but are not limited to, day-care centers, preschools and kindergarten classrooms.
Chronic effect	A response to exposure which may take days, months or years to develop.
Clearance examination	Visual examination and collection of environmental samples by an inspector or risk assessor and analysis by an accredited laboratory upon completion of an abatement project, interim control intervention, rehabilitation, or maintenance job that disturbs lead-based paint.
Clearance levels	Values that indicate the maximum amount of lead permitted in dust on a surface following completion of an abatement activity.
cm	Centimeter; 1/100 of a meter. There are about 2.5 cm in one inch.
Code of Federal Regulations (CFR)	Same as CFR.



Common area	A portion of a building that is generally accessible to all occupants. Such an area may include, but is not limited to, hallways, stairways, laundry and recreational rooms, playgrounds, community centers, garages, and boundary fences.
Competent person	One who is capable of identifying existing and possible lead hazards in the surroundings or working conditions and who has the authority to take prompt corrective measures to eliminate them.
Component or building component	Specific design or structural elements or fixtures of a building, residential dwelling, or child-occupied facility that are distinguished from each other by form, function, and location. These include, but are not limited to, interior components such as: ceilings, crown molding, walls, chair rails, doors, door trim, floors, fireplaces, radiators and other heating units, shelves, shelf supports, stair treads, stair risers, stair stringers, newel posts, railing caps, balustrades, windows and trim (including sashes, window heads, jambs, sills or stools and troughs), built-in cabinets, columns, beams, bathroom vanities, counter tops, and air conditioners; and exterior components such as: painted roofing, chimneys, flashing, gutters and downspouts, ceilings, soffits, fascia boards, rake boards, cornerboards, bulkheads, doors and door trim, fences, floors, joists, lattice work, railings and railing caps, siding, handrails, stair risers and treads, stair stringers, columns, balustrades, window sills or stools and troughs, casings, sashes and troughs, and air conditioners.
Compliance program	The written program that is required under the OSHA Lead Standard for your employer to have before beginning a job where lead is present.
Composite sample	A single sample made up of individual subsamples. Analysis of a composite sample produces the average data for all subsamples.
Containment	A process to protect workers and the environment by controlling exposures to the lead-contaminated dust and debris created during an abatement project.



COSH	Short for "Committee (or Coalition) on Occupational Safety and Health." A COSH group is a group of unions, workers, and professionals working together for safer and healthier working conditions.
Deciliter (dL)	The unit of measure for blood lead levels. The prefix "deci-" means "one-tenth." One deciliter is roughly the same as about one-tenth of a quart, or about 3.4 fluid ounces.
Demolition	The removal of walls (plaster or gypsum) or building components (windows or doors) by sledge hammer or similar tool. If the surfaces are covered with lead-based paint, demolition will create high levels of lead dust. This is a Class 1 Task under the OSHA lead standard.
Detection limit	The minimum amount of a substance that can be reliably measured by a particular method.
Deteriorated paint	any interior or exterior paint or other coating that is peeling, chipping, chalking or cracking, or any paint or coating located on an interior or exterior surface or fixture that is otherwise damaged or separated from the substrate.
Direct-reading XRF	An analyzer that displays lead concentrations as calculated from the lead K X-ray intensity without a picture of the spectrum. Usually expressed in mg/cm ² .
Dripline	Dripline means the area within three feet surrounding the perimeter of a building.
Dust-lead hazard	A dust-lead hazard is surface dust in a residential dwelling or child-occupied facility that contains a mass-per-area concentration of lead equal to or exceeding 40 µg/ft ² on floors or 250 µg/ft ² on interior window sills based on wipe samples.
Dust removal	A form of interim control that involves initial cleaning followed by periodic monitoring and recleaning, as needed.
Dwelling unit	The room or group of rooms within a residential premises used or intended for use by one family or household for living, sleeping, cooking and eating.



EBL child	See Elevated blood lead level (EBL).
Efflorescence	When salt rises to the surface of a material, such as masonry, plaster, or cement, caused by the movement of water through the material. Paint or encapsulants may not adhere to a surface contaminated with efflorescence.
Environmental intervention blood lead level (EIBLL)	A confirmed concentration of lead in whole blood equal to or greater than 20 µg/dL (micrograms of lead per deciliter) for a single test or 15–19 µg/dL in two tests taken at least three months apart.
Elevated blood lead level (EBL)	An excessive absorption of lead in a child. Determined by a confirmed concentration of lead in whole blood of 20 µg/dL (micrograms of lead per deciliter of whole blood) for a single venous test or of 15-19 µg/dL in two consecutive tests taken three to four months apart.
Encapsulant	A substance that forms a barrier between lead-based paint and the environment. Usually a liquid-applied coating (with or without reinforcement materials) or a covering material applied with an adhesive.
Encapsulation	The application of an encapsulant. One method of abatement.
Enclosure	Rigid, durable construction materials that are mechanically fastened to the substrate in order to act as a dust-tight barrier between lead-based paint and the environment. One method of abatement.
Engineering controls	Changes that can be made in the work environment to reduce hazards on the job. OSHA requires employers to make changes in the workplace environment whenever possible to protect worker health and safety.
EPA—Environmental Protection Agency	A federal agency that studies environmental problems and develops regulations to protect human health and the environment.
Evaluation	Risk assessment, paint inspection, reevaluation, investigation, clearance examination, or lead hazard screen.



Exposure monitoring	Air monitoring within an employee's breathing zone to determine the amount of contaminant (e.g., lead) to which he/she is exposed.
Exterior work area	An exterior paved area, soil area, outdoor porch, stairway or other element of trim or walls on the exterior of a building.
<i>Federal Register</i> (FR)	A document published daily by the federal government that contains either proposed or final regulations or notices.
Fetus	An unborn baby from 7 to 8 weeks after fertilization up until birth.
Field blank	A clean sample of the medium used for testing (e.g., filter or wipe) that has been exposed to the sampling conditions, returned to the laboratory, and analyzed as an environmental sample.
Final medical determination	The written opinion given by a doctor that a worker be removed from lead exposure.
Friction surface	An interior or exterior building surface subject to abrasion or friction, such as a window or stair tread.
Generator	Any person whose act or operation produces hazardous waste identified or listed in 40 CFR Part 261 or whose act causes a hazardous waste to come under regulation (40 CFR 260.10).
GFCI	Short for "ground fault circuit interrupter." This is a very sensitive switch which your employer can use to prevent workers from getting an electrical shock. Each extension cord should have its own GFCI.
Gram	A metric unit of weight. A penny weighs about two grams. The abbreviation for gram is "g."
Hazardous waste	Any waste as defined in 40 CFR 261.3 (RCRA). RCRA's definition means a solid waste, or combination of solid wastes, which because of its quantity, concentration, or physical, chemical, or infectious characteristics may (a) cause, or significantly contribute to, an increase in mortality or an increase in serious irreversible, or incapacitating reversible, illness; or (b) pose a substantial present or potential hazard to human health or the environment or when improperly treated, stored, transported, or disposed of, or otherwise managed.



Heat gun	A device capable of heating lead-based paint, causing it to separate from the substrate.
HEPA or High Efficiency Particulate Air Filter	A filter that is 99.97% efficient at filtering out particles of 0.3 microns or greater from a body of air.
HEPA vacuum	A vacuum cleaner which filters air through a HEPA filter.
Housing receiving Federal assistance	Housing which is covered by an application for HUD mortgage insurance, receives housing assistance payments under a program administered by HUD, or otherwise receives more than \$5,000 in project-based assistance under a Federal housing program administered by an agency other than HUD.
HUD—Department of Housing and Urban Development	This federal agency regulates public and some federal assisted housing. HUD published the <i>Guidelines for the Evaluation and Control of Lead-based Paint Hazards in Housing</i> which provide guidance on all aspects of lead-based paint detection and abatement.
HVAC system	The heating, ventilating, and air-conditioning system in any building. The HVAC system should always be turned off before lead abatement work begins.
Impact surface	An interior or exterior building surface that is subject to damage by repeated sudden force, such as certain parts of door or window frames.
Indian Housing Authority (IHA)	A public housing agency established (a) by exercise of a tribe's powers of self-government independent of state law, or (b) by operation of state law providing specifically for housing authorities of Native Americans.
Industrial hygienist	A person who is trained and experienced in looking for safety and health hazards in the workplace and determining the impact of those hazards on the community and workers.
Initial medical surveillance	A set of special blood tests required by OSHA's Interim Final Lead in Construction standard when working with lead. This is also referred to as biological monitoring.



Inspection	A surface-by-surface investigation to determine the presence of lead-based paint. A report is then issued that identifies if there is lead-based paint present and where it is located.
In-place management	See interim controls.
Interim controls	A set of measures designed to temporarily reduce human exposure or likely exposure to lead-based paint hazards. They may include specialized cleaning, repairs, maintenance, painting, temporary containment, ongoing monitoring of lead-based paint hazards or potential hazards, and the establishment and operation of management and resident education programs.
Interior window sill	The portion of the horizontal window ledge that protrudes into the interior of the room, adjacent to the window sash when the window is closed; often called the window stool.
Laboratory analysis	A determination of the lead content in a sample by specific laboratory equipment and methods.
Latex paint	A waterborne emulsion paint made with synthetic binders such as 100-percent acrylic, vinyl acrylic, terpolymer, or styrene acrylic; a stable emulsion of polymers and pigment in water.
Lead (inorganic)	An element, represented by the symbol Pb. Its atomic structure is permanently arranged and is not changed by chemical reactions. Lead can combine chemically with other atoms or molecules to make new compounds. Lead is considered a heavy metal; “heavy” because lead weighs more than the same volume of water, and “metal,” because when it is refined from raw ore into its pure form, lead can be hammered or drawn into shapes.
Lead-accredited laboratory	A laboratory that has been evaluated and received accreditation through EPA’s National Lead Laboratory Accreditation Program (NLLAP) to perform lead measurement or analysis, usually over a specified period of time.
Lead-based paint	Paint or other surface coatings that contain lead equal to or in excess of 1.0 milligrams per square centimeter or more than 0.5 percent by weight.



Lead-based paint activities	In the case of target housing and child-occupied facilities: inspection, risk assessment, and abatement.
Lead-based paint hazard	hazardous lead-based paint, dust-lead hazard or soil-lead hazard as identified in §745.65. (See also paint-lead hazard, dust-lead hazard and soil-lead hazard.)
Lead-based paint hazard control	Activities to control and eliminate lead-based paint hazards, including interim controls and abatement.
Lead-based paint-free certification	Describes a rental dwelling certified by a certified lead-based paint inspector to contain no lead at or above 1.0 mg/cm ² .
Lead-based paint hazard-free dwelling	A dwelling that contains no lead-based paint and has interior dust and exterior soil lead levels below the applicable EPA or state/Indian Country standards.
Lead-hazard screen	A limited risk assessment activity that involves limited paint and dust sampling.
Lead-specific detergent	A cleaning agent manufactured specifically for cleaning and removing leaded dust or other lead contamination.
m ³	Short for "cubic meter." It is a metric unit of volume. You breathe between 1 and 2 cubic meters of air every hour when you are working. A cubic meter is about the size of a blue U.S. Post Office box.
Manifest	The shipping document—EPA form 8700-22— your employer will use for identifying the quantity, composition, origin, routing, and destination of hazardous waste during its transport from the point of generation to the point of treatment, storage, or disposal.
Medical removal	The temporary removal of workers due to elevated blood lead levels as defined in the OSHA Lead Standard (currently 50 µg/dL).
Medical removal protection	Your employer must pay your salary if you are medically removed from a lead abatement job. Your employer must pay you as long as the job exists or up to 18 months.



Medical surveillance program	A special program of medical exams an employer must make available to workers under the OSHA lead standard.
mg	Milligram. There are one thousand milligrams in a gram.
mg/cm ²	Milligrams (mg) per square centimeter (cm ²). When surfaces are tested for lead using an XRF analyzer, the amount of lead is measured in milligrams of lead per square centimeter (mg/cm ²). When a paint chip sample is taken from a measured area, the results may also be provided in mg/cm ² .
Micrograms	One millionth of a gram: µg; the prefix “micro-” means “1/1,000,000 of” (one millionth of).
Multifamily dwelling	A building that contains more than four separate residential dwelling units. One or more persons may live in each unit.
NIOSH	National Institute for Occupational Safety and Health. A federal agency which does research and suggests new laws on occupational health and safety to OSHA. NIOSH tests and certifies respirators.
Occupational	Having to do with the workplace and working.
Off-site paint removal	The removal of paint at a site away from the abatement project, such as stripping lead-based paint from the surface of a component (e.g., a door) at the facilities of a commercial paint-stripping operation. Such procedures are often performed in chemical tanks.
On-site paint removal	The removal of lead-based paint down to the bare substrate usually through heat, chemical or mechanical means. The affected surface/component usually remains in place on the premises during this removal process.
OSHA— Occupational Health and Safety Administration	The main federal agency that issues and enforces safety and health standards in the workplace.
Paint chip sample	A sample of paint that is removed from a surface (down to the substrate) and analyzed for lead content.



Paint-lead hazard	A paint-lead hazard is any of the following: (1) Any lead-based paint on a friction surface that is subject to abrasion and where the lead dust levels on the nearest horizontal surface underneath the friction surface (e.g., the window sill, or floor) are equal to or greater than the dust-lead hazard levels identified in paragraph (b) of this section. (2) Any damaged or otherwise deteriorated lead-based paint on an impact surface that is caused by impact from a related building component (such as a door knob that knocks into a wall or a door that knocks against its door frame). (3) Any chewable lead-based painted surface on which there is evidence of teeth marks. (4) Any other deteriorated lead-based paint in any residential building or child-occupied facility or on the exterior of any residential building or child-occupied facility.
Paint testing	The determination of the presence or the absence of lead-based paint on deteriorated paint surfaces or painted surfaces to be disturbed. Paint testing must be done by certified lead-based paint inspector or risk assessor.
Performance characteristic sheet (PCS)	A document developed by EPA and HUD that provides information on portable XRF instruments. The PCS describes how to calibrate the XRF, tells when test results may not provide a valid analysis, and gives other important information about the XRF.
Permanently covered soil	Soil that has been separated from human contact by the placement of a barrier consisting of solid, relatively impermeable materials, such as pavement or concrete. Grass, mulch, and other landscaping materials are not considered permanent covering.
Permissible exposure limit (PEL)	The maximum worker exposure to lead under the OSHA lead in construction standard. No employee may be exposed to lead at airborne concentrations greater than 50 µg/m ³ averaged over an 8 hour period.
Personal protective equipment (PPE)	Equipment for protecting the eyes, face, head, and/or arms and legs. Includes protective clothing, respiratory devices, and protective shields: PPE is used when hazards are encountered that may cause bodily injury or impairment.



Personal samples	Air samples collected from within the breathing zone of a worker, but outside the respirator. The samples are collected with a personal sampling pump, pulling one to four liters/minute of air.
Physician or other licensed health care provider (PLHCP)	an individual whose legally permitted scope of practice (i.e., license, registration, or certification) allows him or her to independently provide, or be delegated the responsibility to provide some or all of the health care services required by the medical evaluation section of OSHA's respiratory protection standard [1910.134(e)].
Pigments	Chemicals that have color or properties which affect color. Usually, a small amount of these chemicals is mixed with another material to color all of the material. Lead carbonate and lead oxide are chemical forms of lead used as pigments.
Play area	An area of frequent soil contact by children of less than six years of age, as indicated by the presence of play equipment or toys or other children's possessions, observations of play patterns, or information provided by parents, residents or property owners.
Poly	Short for polyethylene sheet plastic. This is a plastic sheet that is used to protect surfaces while lead-based paint abatement or interim controls are being done.
ppm	"Parts per million," meaning the weight of one part per weight of the total amount of material. For example, a lead concentration of 1 ppm expresses the ratio of one gram of lead dissolved into one million (1,000,000) grams of water.
Primary prevention	The process of controlling lead hazards to prevent exposure before a child is poisoned.
Public Housing Agency (PHA)	Any state, county, municipality, or other governmental entity or public body (or agency or instrumentality thereof) which is authorized to engage or assist in the development or operation of housing for low income families.
Quality assurance (QA)	A system of activities involving planning, quality control, quality assessment, reporting, and quality improvement to ensure that a product or service meets defined standards of quality within a stated level of confidence.



Quality control (QC)	The overall system of technical activities whose purpose is to measure and control the quality of a product or service so that it meets the needs of users. The aim is to provide a level of quality that is satisfactory, adequate, dependable, and economical.
Random sample	A sample drawn from a population in a way that allows each member of the population to have an equal chance of being selected. Random sampling is a process used to identify locations for the lead-based paint inspections in multifamily dwellings.
RCRA	Resource Conservation and Recovery Act of 1976. What we commonly refer to as RCRA is an amendment to the Solid Waste Disposal Act of 1965. RCRA was amended in 1980 and 1984 by the Hazardous and Solid Waste Amendments.
Reevaluation	In lead hazard control work, the combination of a visual assessment and collection of environmental samples performed by a certified risk assessor to determine if a previously implemented lead-based paint hazard control measure is still effective and if the dwelling remains lead-safe.
Regulation or Rule	All or part of any federal statement of general or particular applicability and future effect designed to: (1) implement, interpret, or prescribe law or policy or (2) describe the federal Department's organization or its procedure or practice requirements.
Renovation	Work that involves construction tasks such as window replacement, weatherization, remodeling, or modification of any existing structure that results in the disturbance of painted surfaces.
Representative sample	A sample of a material to be disposed of (e.g., painted components, waste sample pile, or waste stream) which can be expected to exhibit the average properties of that type of debris.
Residential dwelling	(1) A detached single family dwelling unit, including attached structures such as porches and stoops; or (2) a single family dwelling unit in a structure that contains more than one separate residential dwelling unit in which one or more people may live.
Resident	A person who lives in a dwelling.



Risk assessment	An on-site investigation to determine the existence, nature, severity, and location of lead-based paint hazards. The risk assessor will provide a report explaining the results of the investigation and how to reduce the lead-based paint hazards.
Room equivalent	An identifiable part of a residence, such as a room, a house exterior, a foyer, staircase, hallway, or an exterior area (exterior areas contain items such as play areas, painted swing sets, painted sandboxes, etc.). Closets or other areas adjoining room equivalents should be designated room equivalents only if large.
Sample site	A specific spot on a surface being tested for lead concentration or contamination.
Screening	The process of testing children to determine if they have elevated blood lead levels.
Secondary prevention	The process of identifying children who have elevated blood lead levels through screening, and then controlling or eliminating the sources of further exposure.
Sodium rhodizonate	A chemical used to test a paint sample for the presence of lead. A positive test is characterized by a pink or red discoloration of the paint film cross section or of the applicator tip.
Sodium sulfide	A chemical used to test a paint sample for the presence of lead. A positive test is characterized by a gray or black discoloration of the paint film cross section.
Soil-lead hazard	A soil-lead hazard is bare soil on residential real property or on the property of a child-occupied facility that contains total lead equal to or exceeding 400 parts per million ($\mu\text{g/g}$) in a play area or average of 1,200 parts per million of bare soil in the rest of the yard based on soil samples.
Solid waste	As defined in RCRA means any garbage, refuse, sludge from a waste treatment plant, water supply treatment plant, or air pollution control facility and other discarded material, including solid, liquid, semisolid, or contained gaseous material resulting from industrial, commercial, mining, and agricultural operations, and from community activities. Does not include solid or dissolved material in domestic sewage, or solid or dissolved materials in irrigation return flows or industrial discharges which are point sources subject to permits under the Clean Water Act, or special nuclear or by-product material as defined by the Atomic Energy Act of 1954.



Spectrum analyzer XRF	A type of XRF analyzer which provides the operator with a plot of the energy and intensity of both “K” and “L” X-rays, as well as a calculated lead concentration.
Spiked sample	A sample prepared by adding a known mass of the substance to be analyzed (e.g., leaded dust) to a specific amount of matrix sample (e.g., one dust wipe). The known concentration of the substance to be analyzed is compared against the laboratory's results to check for accuracy.
Standard	Used in two ways in this manual: (a) levels established by law or regulation, such as 1.0 mg/cm ² ; (b) materials to which known quantities of lead have been applied; used to evaluate the accuracy and performance of the XRF analyzer, usually called Standard Reference Materials.
Storage	The holding of hazardous waste for a temporary period, after which the hazardous waste is treated, disposed of, or stored elsewhere.
Subsample	A representative portion of a sample. A subsample may be either a field sample or a laboratory sample. A subsample is often combined with other subsamples to produce a composite sample.
Substrate	A surface upon which paint or varnish has been or may be applied. Examples included in the HUD <i>Guidelines</i> are: wood, plaster, metal, brick, drywall, and concrete. Substrates can contain lead absorbed from paint or from other sources.
Substrate correction	Reducing the apparent lead reading by the level attributable to the substrate. The substrate correction level is determined by taking a total of 6 readings on two different locations of each bare substrate. The Performance Characteristic Sheet must be consulted to determine if substrate correction is needed for the analyzer being used.
Substrate effect	The returning of backscattered radiation from the paint, substrate or underlying material to the XRF analyzer. When counted as lead X-rays by an XRF, this radiation contributes to the bias. The inspector may have to adjust for this effect when using some XRF analyzers.
Tack cloth	A soft, sticky, lint-free cloth used to clean dust off of surfaces that cannot be washed.



Target housing	Any housing constructed prior to 1978, except housing for the elderly or persons with disabilities (unless any one or more children age 6 years or under resides or is expected to reside in such housing for the elderly or persons with disabilities) or any 0-bedroom dwelling (e.g. dormitory, studio apartment).
Tertiary prevention	Providing medical treatment to children with elevated blood lead levels to prevent more serious injury or death.
Testing combination	A unique surface to be tested that is characterized by the room equivalent, component, and substrate type.
Title X (10)	The Residential Lead Hazard Reduction Act of 1992. It requires the government to regulate people's exposure to lead much more closely than had been done in previous years.
Toxicity characteristic leachate procedure (TCLP)	One of the tests for the determination of whether a solid waste is classified as a hazardous substance.
Trisodium phosphate (TSP) detergent	A detergent that contains trisodium phosphate.
Trough	See window trough.
µg	Microgram. The prefix "micro-" means 1/1,000,000 (or one millionth); a microgram is 1/1,000,000 of a gram and 1/1,000 of a milligram; equal to about 35 billionths of an ounce.
Visual assessment	Looking for (1) deteriorated paint; (2) visible surface dust, debris and residue as part of a risk assessment or clearance examination; or (3) the completion or failure of a hazard reduction measure.
Visual inspection	The visual examination of a residential dwelling or a child-occupied facility following an abatement to determine whether or not the abatement has been successfully completed.
Visual examination	The examination of a residential dwelling or a child-occupied facility to determine the existence of deteriorated lead-based paint or other potential sources of lead-based paint hazards.



Wet sanding or wet scraping	A process of removing loose paint in which the painted surface to be sanded or scraped is kept wet to minimize the spread of paint chips and airborne dust.
Window trough	For a typical double-hung window, the portion of the exterior window sill between the interior window sill (or stool) and the frame of the storm window. If there is no storm window, the window trough is the area that receives both the upper and lower window sashes when both are lowered. Sometimes inaccurately called the window “well.”
Window well	the space that provides exterior access and/or light to a window that is below grade, i.e., below the level of the surrounding earth or pavement.
X-ray fluorescence	the emission of X-rays from excited atoms produced by the impact of high-energy electron, other particles, or primary beam of other X-rays.
X-ray fluorescence analyzer (XRF)	An instrument which estimates lead concentration in milligrams per square centimeter (mg/cm ²) using X-ray fluorescence.
ZPP test	Zinc protoporphyrin test. It is a type of blood test which can show a person's lead exposure over the previous two to three months.



Resources

U.S. EPA Regional Offices

USEPA Region I
Lead Coordinator
John F. Kennedy Federal Building
One Congress Street
Boston, MA 02203
617-565-3471

USEPA Region II
Lead Coordinator
290 Broadway
New York, NY 10007-1866
732-321-6671

USEPA Region III
Lead Coordinator
1650 Arch St.
Philadelphia, PA 19103
215-814-2084

USEPA Region IV
Lead Coordinator
61 Forsyth St
Atlanta, GA 30303-3104
404-562-8998

USEPA Region V
Lead Coordinator
77 West Jackson Boulevard
Chicago, IL 60604
312-886-7836

USEPA Region VI
Lead Coordinator
1445 Ross Avenue, 12th Floor
Dallas, TX 75202-2733
214-665-7577

USEPA Region VII
Lead Coordinator
726 Minnesota Ave.
Kansas City, KS 66101
913-551-7518

USEPA Region VIII
Lead Coordinator
999 18th St. - Suite 500
Denver, CO 80202-2466
303-312-6021

USEPA Region IX
Lead Coordinator
75 Hawthorne St.
San Francisco, CA 94105-3901
415-744-1094

USEPA Region X
Lead Coordinator
1200 Sixth Ave.
Seattle, WA 98101
206-553-1985

OSHA Regional Offices

OSHA Region I
133 Portland Street, 1st Floor
Boston, MA 02114
617-565-7164

OSHA Region II
201 Varick St.
New York, NY 10014
212-337-2378

OSHA Region III
Gateway Building, Suite 2100
3535 Market Street
Philadelphia, PA 19104
215-596-1201

OSHA Region IV
1375 Peachtree St., NE, Suite 587
Atlanta, GA 30367
404-347-3573

OSHA Region V
230 South Dearborn St.
Room 3244
Chicago, IL 60604
312-353-2220

OSHA Region VI
525 Griffin St., Room 602
Dallas, TX 75202
214-767-4731



OSHA Region VII
City Center Square
1100 Main St., Suite 800
Kansas City, MO 64105
816-426-5861

OSHA Region VIII
1999 Broadway, Suite 1690
Denver, CO 80202-5716
303-391-5858

Federal Agencies

Agency for Toxic Substances and Disease
Registry (ATSDR)
Office of Policy and External Affairs
404-639-0501
atsdr1.atsdr.cdc.gov

Centers for Disease Control and Prevention
(CDC)
Lead Poisoning Prevention
404-639-3311
www.cdc.gov

Environmental Protection Agency
TSCA assistance hotline
202-554-1404
www.epa.gov/lead

Private Organizations

Alliance to End Childhood Lead Poisoning
227 Massachusetts Ave., NE
Suite 200
Washington, DC 20002
202-543-1147
www.aeclp.org

Association of Occupational and
Environmental Clinics
1010 Vermont Ave, NW #513
Washington, DC 20005
202-347-4976

Environmental Defense Fund
1875 Connecticut Ave., NW
Suite 1016
Washington, DC 20009
202-387-3500
www.edf.org

OSHA Region IX
71 Stevenson St. Room 420
San Francisco, CA 94105
415-744-6670

OSHA Region X
1111 Third Avenue, Suite 715
Seattle, WA 98101-3212
206-553-5930

National Institute for Environmental Health
Science (NIEHS)
919-541-0752
www.niehs.nih.gov

National Institute for Occupational Safety and
Health (NIOSH)
800-35-NIOSH
www.cdc.gov/niosh

Department of Housing and Urban
Development
Office of Health Homes and Lead Hazard
Control
202-755-1785
www.hud.gov/offices/lead
HUD USER 800-245-2691

National Center for Healthy Housing
10227 Wincopin Circle, Suite 205
Columbia, Maryland 21044
410-992-0712
www.enterprisefoundation.org/howwork/
housing/leadsafe.htm

National Lead Information Center
800-424-LEAD
www.epa.gov/lead/nlic.htm

Society for Occupational and Environmental
Health
6728 Old McLean Village Dr.
McLean, VA 22101
703-556-9222

Resources



The Environmental Information Asso.
4915 Auburn Ave., Suite 303
Bethesda, MD 20814
301-961-4999
www.eia-usa.org

National Lead Abatement Council
P.O. Box 535
Olney, MD 20832
301-924-5490





APPENDIX A

LEAD ABATEMENT IN HOUSING

Learning objectives	A-3
Skit: A home abatement job	A-4
Discussion questions	A-4
Doing the abatement	A-5
Windows	A-6
Doors	A-10
Woodwork (not including doors and windows)	A-12
Walls	A-13
Ceilings	A-17
Floors	A-18
Staircases	A-20
Porches	A-22
Outside brick and cement	A-23
Key facts for Appendix A	A-25
For more information	A-26



Lead Abatement for Workers



Learning objectives

In this appendix you will learn how to treat lead-based paint on

- windows
- doors
- woodwork
- walls
- ceilings
- floors
- staircases
- porches

You will also review the differences between abatement and interim controls.



Skit: A home abatement job

Sam has worked in a lot of trades. He was recently trained in lead abatement because he heard there was some work available. Later, Sam and his buddy, George, got a job doing home abatement for a neighbor. They needed to get some experience, so they bid low in order to get the job.

Sam: We should've looked over the inspection report before submitting that bid. There's lead-based paint everywhere!

George: You're telling me. We're going to have to cut corners somehow. How about the windows?

Sam: No, let's not skimp there. They're a big hazard. Let's go ahead and replace them, but get cheaper windows.

George: How about if we just repaint the doors and replace the stop?

Sam: Not a bad idea, and we can just repaint the ceiling where it needs it.

George: All right, good plan! Boy, could I use a smoke. It's going to be tough smoking only outside.

Discussion questions

1. What do you think of Sam's and George's plan?
2. Can you manage the hazard of lead-based paint on a surface such as a window by just repainting it? Why or why not?
3. Does it make sense to repaint the doors and replace the stops?
4. Why do lead abatement workers who smoke have a harder time keeping their lead exposure down?





Doing the abatement

Abatement means getting rid of lead-based paint hazards. Abatement methods are discussed in Chapter 6.

Whenever you do abatement you must use the personal protection that is appropriate for the job. You can find this information in the HUD *Guidelines*. OSHA says you must be trained on PPE and the hazards of working with lead. The following chart shows which methods are used for different parts of a home.

Method	Where can you best use it?
REPLACEMENT	<ul style="list-style-type: none">• Windows, doors, moldings• Any easily removed component
ENCAPSULATION	<ul style="list-style-type: none">• Walls, ceilings, trim
ENCLOSURE	<ul style="list-style-type: none">• Floors, pipes, ceilings, exterior trim
PAINT REMOVAL	
Wet Scraping	<ul style="list-style-type: none">• As an interim control for loose paint• Not as a removal method for large areas
Heat Gun	<ul style="list-style-type: none">• Flat surfaces• Thick layers of paint (softens them)
Caustic Paste	<ul style="list-style-type: none">• Decorative molding• Soft woods, brick, cement
Solvents	<ul style="list-style-type: none">• Metal substrates• To clean residue left by other methods
Off-site Chemical Stripping	<ul style="list-style-type: none">• Restoration work• Doors, mantels, metal railing, trim



The greatest levels of lead dust are often found in the window troughs.

Windows

Lead-painted windows are often the greatest source of lead dust.

Opening and closing windows causes **friction** between painted surfaces. This friction creates dust. Windows are exposed to water, sun, wind, and temperature changes. These all cause paint to deteriorate and create dust.

Put extra poly up when you work on windows. Attach the poly to the wall underneath the window and extend the poly out at least 6 feet. Do this both inside and outside the window.

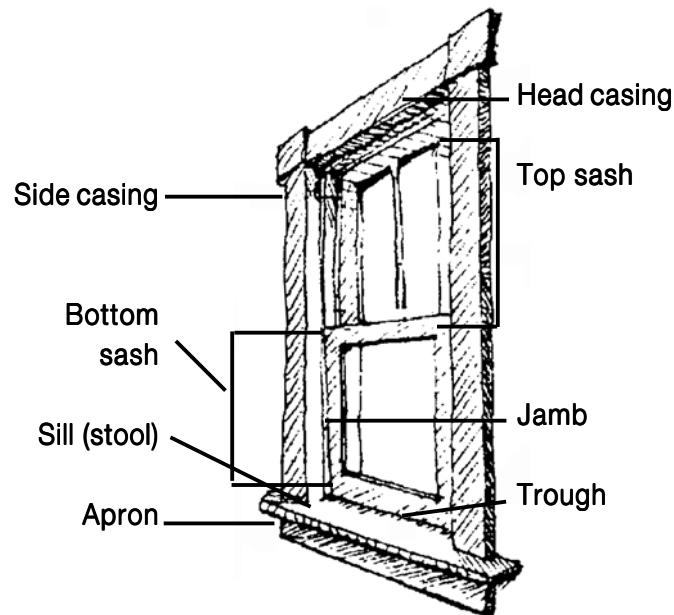

Window abatement

Replacing lead-painted windows is a good choice because

- raising and lowering the windows may produce lead dust;
- children like to play in and near windows;
- old windows are expensive to maintain;
- new windows can save energy;
- new windows may increase property value.

If you must keep the old sashes, you can

- Remove the sashes and have them stripped off site whenever possible. Clean, reglue, refinish, and paint them before reinstalling.
- Replace the stops and the parting bead.
- Enclose or chemically strip the jamb.

Replace window units.



- Replace the casing and the apron.
- Replace the sill (stool) or enclose it.
- Enclose the outside of the window with wood or coil stock. **WARNING:** Enclosing wood with coil stock may cause exterior wood to rot.

Interim controls

If you are not going to abate lead-painted windows right away, you can still treat them so they create less lead dust. (Make sure these options are legal in your state and local area!)

The sashes

The goal is to eliminate friction against leaded surfaces.

- **Fix the top sash in place.**

Nail or screw in wood blocks under the top sash to hold it in place. (Make sure this is legal to do in your area.) This way you will only have to work the bottom sash.

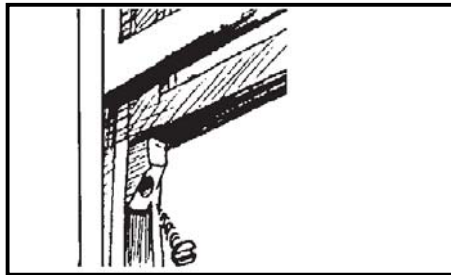

- **Remove and dispose of inside stop.** Do the same with the **parting bead** if you are treating the top sash as well as the bottom.

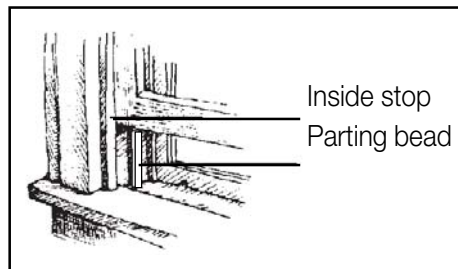

- **Remove the bottom sash.** If the counter-weight ropes or chains are in place, do not let them drop into the weight compartment.

- **Remove the paint from edges that rub against stop, sill (stool), and parting bead.** Wet planing is a good method.

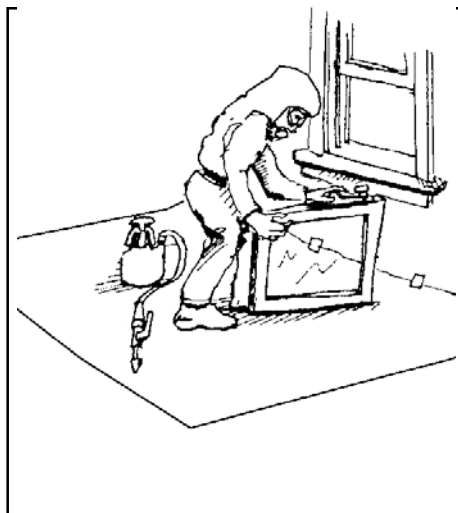



- **Rehang the sash(es)** in a compression track. If there is no counter weight or spring system, install one.

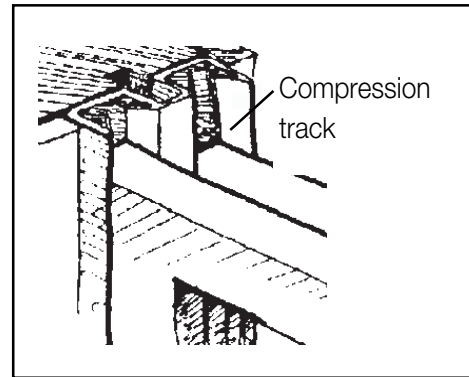

The trough and the sill (stool)

When a window sash is lowered, the opening the sash fits into is called a **trough**. This area is typically one of the highest dust areas.

- **HEPA vacuum the trough.**
- **Create a cleanable surface.** Enclose trough with vinyl or metal coil stock. Back caulk the material and nail it down. Caulk the edges from the top.
- **Open or drill out weep holes.** (Weep holes are drain holes in the bottom of storm windows.)
- **The sill** (most window makers and carpenters call this the “**stool**”) is at the base of the window, inside the house. Children often look out the window and may put their mouths on the sill. **Wet plane or enclose the edge facing the room.** You may also need to enclose or remove the paint from the top surface.

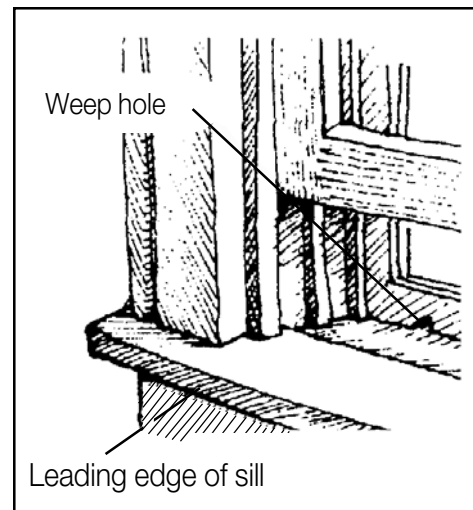
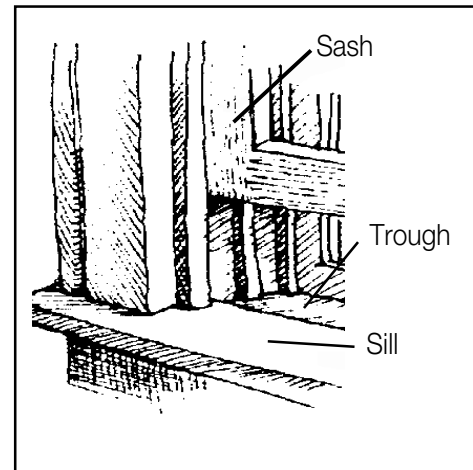



The casing, apron, jamb

- If the paint on the casing, apron, and jamb is in good shape, you may be able to just wet scrape and repaint. Remember, paint is not an encapsulant. Repainting is only a temporary solution!
- If the outside jamb is still exposed and the outside casing is damaged, wet scraping and painting may not be enough. Seal any exposed wood with boiled linseed oil (or equivalent) and paint. Enclosing the trim with coil stock will also work, but may cause exterior wood to rot.

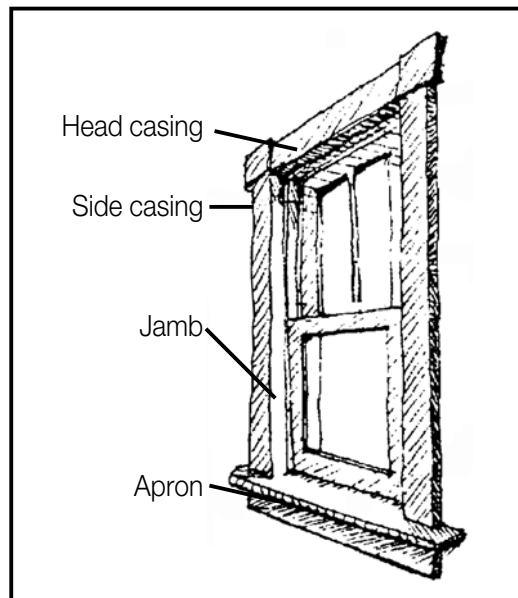



Replace doors.

Lead-painted doors are a source of lead dust.

Doors

Opening and closing doors creates an **impact**. When you impact a lead-based painted surface again and again, lead dust is created. Outside doors are exposed to water, sun, wind, and temperature changes. These cause paint to **deteriorate** and create lead dust.

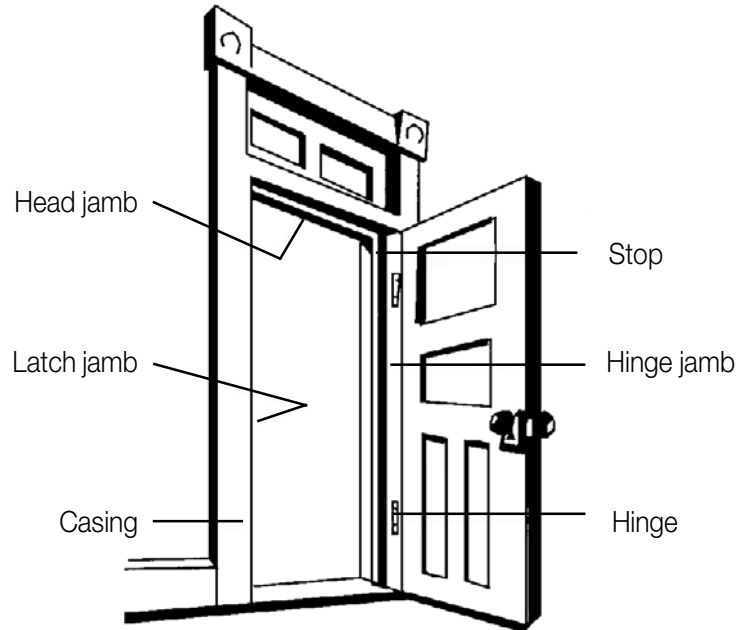

Door abatement

Replacement is often the easiest, most cost-effective method. There are a number of ways to do this:

- Replace door and door stop.
- Install a pre-hung door and keep old jamb.
- Install a pre-hung door and new casing.

Taking out old casing can damage the surrounding wall. New casing should be wide enough to cover any damage. It should also cover the jamb edge and the area where the old casing meets the wall.

Remove the paint off site.

If you must preserve the door and casing, send them to be **stripped off site**. Clean them when they come back. Reglue, fill in any holes or cracks, and wet sand them. Reinstall and paint after inspection.



Remove the paint on site.

You can remove the lead-based paint **on site** with chemical stripping, wet scraping, or by using a heat gun. Needle guns equipped with HEPA filters may be used for metal doors. These methods require time and patience.

Interim Controls

If you are not going to abate lead-painted door systems, you can still treat them so they create less lead dust. (Make sure these options are legal in your state and local area!)

1. **Replace the stop—or wet plane it.**
2. **Wet plane the corner edges** of the door on the latch side where it contacts the stop.
3. **Re-set the hinge screws if necessary.**

The door should not make any wood-to-wood contact, except against the latch (knob) side stop. If it does, rehang the door or plane the hinge side of the door until there is about 1/8-inch space.



Woodwork (not including doors and windows)

Lead-painted woodwork can be a source of lead dust, especially impact points such as chair rails, baseboards, and jamb edges.

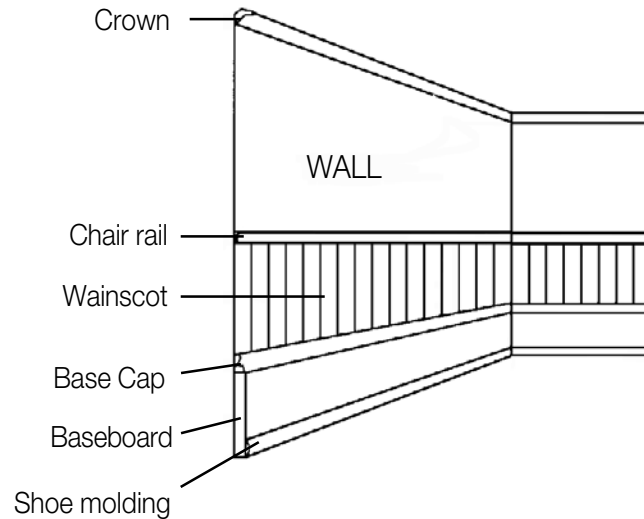

Replace or encapsulate woodwork.

Woodwork abatement

- **Replace**

Woodwork can be replaced. Remember to back caulk and nail down replacement parts when you install them.

- **Encapsulate**

Encapsulate if the paint is in good shape.

Interim controls

If you are not going to abate lead-painted woodwork, you can still treat it so that it creates less lead dust. (Make sure these options are legal in your state and local area!)

- **Wet plane and enclose any edges** on surfaces where children may put their mouths.
- **Where paint is intact, paint over with a high-grade paint.** Paint is not an encapsulant. Repainting is only a temporary measure!
- **Cover impact points** (chair rails, baseboards, jamb edges) with a strip of solid lattice or corner protector.



Walls

Kitchen, bathroom, and basement walls were often painted with lead-based paint. Other walls in a home can have lead-based paint, too. Encapsulation and enclosure are the methods most often used to abate lead-painted walls. Regardless of the type of abatement chosen, the cause of the damage (e.g., leaking roof, leaking chimney, termites, etc.) to the wall(s) **must be fixed first**.

Wall abatement

- **Encapsulating walls**

The wall must be sound. Plaster or plaster board must be in good shape. There cannot be any major peeling of the existing paint layers. If the wall is not sound, the encapsulant could pull right off the wall. If the wall is sound, but has minor cracks or chips, a mesh system works well. It will seal the cracks and chips. Old wallpaper should be removed because it can cause the encapsulant to fail.

- **Prepare the wall.** Wet scrape any loose paint. Clean off any oil, dirt, and grease with a solvent or detergent.
- **Wear the right protective gear.** You may need to use chemical-resistant protective gear. Wear your respirator and goggles. Check the encapsulant MSDS. Make sure you have the right filters for your respirator. You may need a combination filter.
- **Mix the encapsulant.** Follow the manufacturer's directions.
- **Do a "test patch."**
- **Ventilate the area.** Some products need extra ventilation.

- **Enclosing walls**

Before you enclose a wall, label the wall surface "lead-based paint." This will alert anyone who works on the wall later on that they are disturbing lead-based paint.

Both sound walls and damaged walls can be enclosed. Enclosure is recommended where the substrate (wall material) is damaged. Before you install an enclosure, you have to get rid of all moisture sources and let the walls dry out.

Fur out the wall.

When plaster is damaged, you must install enclosure material to studs or furring strips. Furring strips are thin strips of wood you fasten to the studs. This way, even if the plaster fails, the enclosure will stand. Furring strips should be attached with adhesive **and** screws into the studs. Putting up furring strips is called "furring out the wall."

Encapsulate or enclose walls.

Prepare the wall with wet scraping and clean.

Label the old wall "LEAD-BASED PAINT" before you enclose it.



- First lay out a horizontal furring strip along the base of the wall.
- Then put up vertical furring strips. Line them up with the studs.

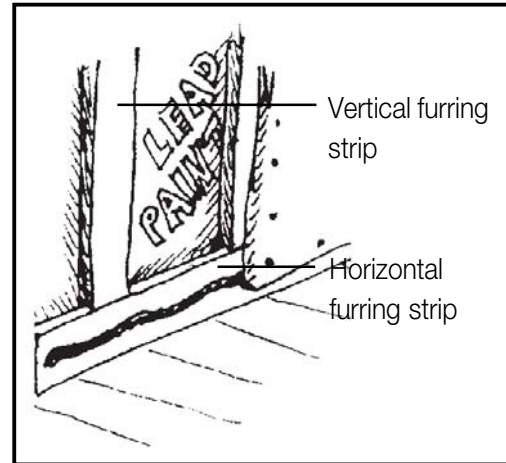

Fasten the enclosure material.

Fasten the enclosure material to the studs. If you furred out the wall, fasten the enclosure material to the furring strips. Use both adhesive and screws. If the wall is plaster on masonry and the plaster is sound, the enclosure material can be attached with a combination of mastic and masonry fasteners.

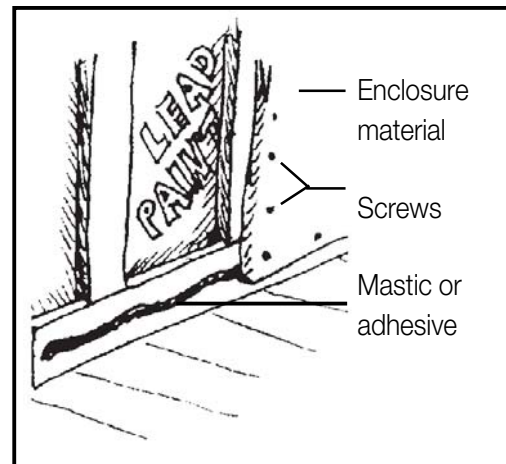

Create a dust-tight seal.

Create a dust-tight seal.

Paint deteriorates more quickly behind an enclosure. All edges of an enclosure—especially the bottom—must be sealed well. If you don't create a good seal, lead dust will leak out.

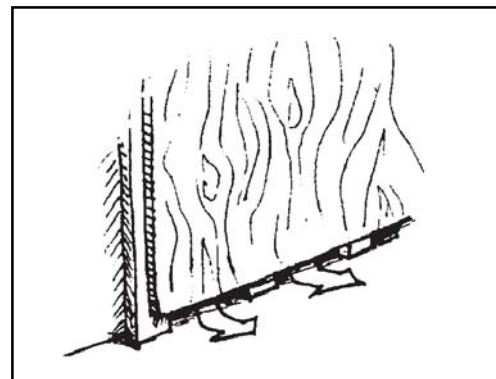



Seal the bottom edge.

- Caulk the enclosure material at the bottom.
- Back-caulk and nail the baseboard in place.
- Back-caulk, bottom-caulk, and nail the shoe molding in place.

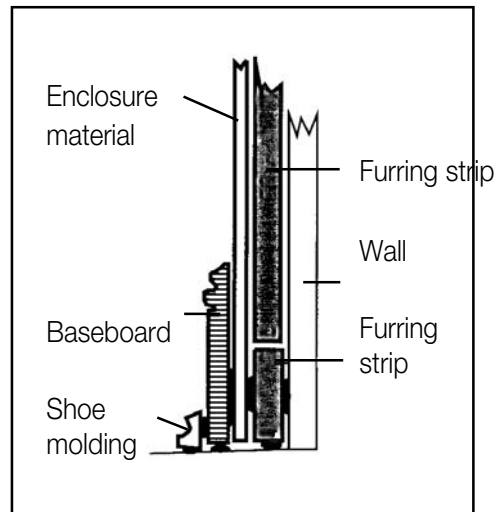

Seal the edges—especially the bottom.

Seal the seams and other edges.

- Back-caulk all the seams that aren't taped and spackled. Use a high quality adhesive caulk.
- Use a “J-channel” where drywall meets a finished surface. A J-channel is a final strip you attach to the rough edge of drywall to make a finished edge. It's called a “J-channel” because of its shape. Caulk the outside edge so it seals with the finished surface. Screw the drywall in place.

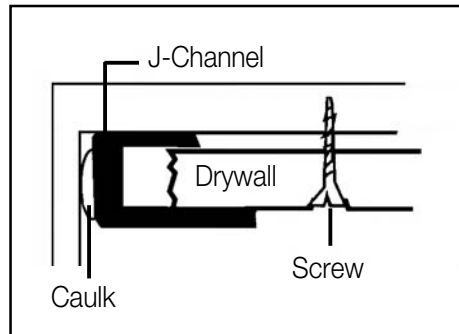

- **Replacing walls**

Replacing drywall and plaster is extremely messy and expensive. Sometimes it is the most practical solution—for example, when partition walls will be built or new electric, plumbing, or heating systems will be installed within a wall.

Taking out the old walls or wall substrate (plaster) is demolition work. Follow all worker and environmental protection rules.

- Remove all furniture and personal items.
- Seal off the area.
- Put down a second layer of poly on the floor for added protection.
- Keep area misted to lower dust levels.
- Clean up often and dispose of waste.
- Wear protective suits and respirators and use extra ventilation.

**Interim controls**

If the lead-painted walls are not damaged, flaking, or peeling, you might just wet scrape and repaint them. Remember, paint is not an encapsulant. Repainting is not an abatement method, it is only a temporary solution. When the new paint does chip and peel, the old paint may chip with it. Then it will create lead dust.



Ceilings

If a lead-painted ceiling is damaged, it should be enclosed. Replacement is also an option, but it will create large amounts of dust and debris in addition to being much more expensive and difficult to do. Regardless of the type of abatement chosen, the cause of the damage to the ceiling (e.g., leaking plumbing, poor painting preparation, unvented bathroom) **must** be fixed **first**. Ceilings can be enclosed with drywall—or any other type of covering that seals the seams and edges. An enclosure must be dust-tight. It must be sealed along all edges, joints, and seams. **A drop ceiling is not an enclosure.**

Ceiling abatement

Never attach the new ceiling to the old ceiling itself. New drywall must be attached to the ceiling beams—called “joists”—with drywall screws. To find the joists, use a drywall dagger and do the following:

1. Cut to the joists on both sides.
2. Mark the center of each joist on the wall.
3. Draw a chalk line across the ceiling from center mark to center mark.
4. Screw the new drywall into the joists along these lines.
5. Tape and spackle all edges.
6. Where new drywall meets a finished surface, use a J-channel.

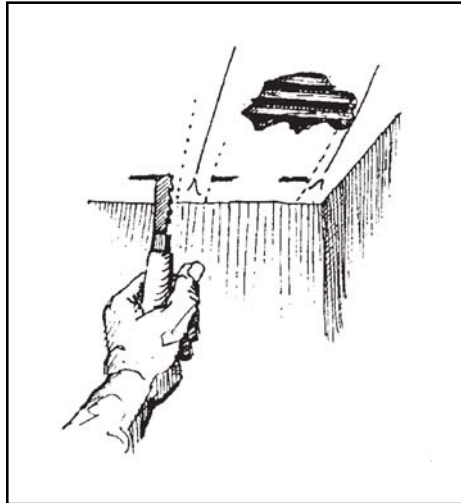

Enclose ceilings.

Interim controls

If the ceiling is not damaged, flaking, or peeling, you might repaint it to take care of the lead hazard in the short run. Remember, paint is not an encapsulant. Repainting is not an abatement method. It is only a temporary solution. When the old paint does chip and peel, it will create lead dust.



Floors

Lead-painted floors are a major source of lead dust. They are impact and friction surfaces. People walk on them. Children and pets play on them. Things get dropped on and dragged around on them. These activities create lead dust.

Floors should be abated last. Ceilings, walls, and windows need to be done first. This will reduce the amount of lead dust that gets on the new lead-free floor. The less dust that gets on the floor, the easier it will be to clean at the end of the job.

Floor abatement

1. **Clean the floor to remove lead dust with an all-purpose cleaner or some other cleaner made especially for lead.**
2. **Install a subfloor before installing the finished floor** (unless you are installing a new tongue-and-groove floor). Use 1/2-inch or thicker plywood or tempered underlayment. Do **not** use masonite. Back caulk the edges, especially the borders. Nail the subfloor down. HEPA vacuum the floor and all cracks. Fill large cracks with a filler that will not turn brittle or break.
3. **Install the finished floor.** You can use vinyl, tile, or wood. (If you use urethane, use extra ventilation and follow instructions carefully.) You can also place carpeting on top of the newly installed floor, but wait until final cleanup is complete before installing. Carpeting alone is not an enclosure. Wall-to-wall carpeting is discouraged in homes with lead-based paint because it is not cleanable.

Enclose or replace floors.

Back caulk and nail in subfloor.

Carpets collect more lead dust than bare floors.

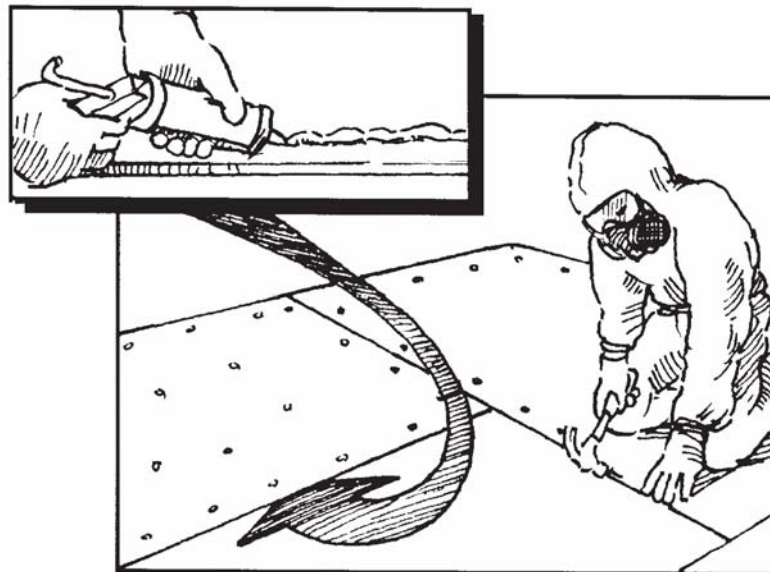



Carpet removal

Lead dust falls on and sticks to carpet fibers. Lead dust settles under the carpet. Taking out lead-contaminated carpets can be dangerous. You will be exposed to high levels of lead dust.

1. Seal the area from other parts of the house.
2. Wear a respirator and protective clothing.
3. Ventilate the area.
4. Dampen rug and any dust underneath to keep the dust levels down.
5. Wrap up the carpet in 6-mil poly and seal it with duct tape.
6. HEPA vacuum the area and wash over it with an all-purpose cleaning solution.

Carpets contaminated with lead are very difficult to clean. You or your employer should advise the owner of this difficulty. Do **not** remove the carpet without the owner's written permission. If the carpet is not removed, it must be HEPA vacuumed very slowly.

After the abatement

Lead-free floors will collect lead dust.

Floors should be abated at the end of the job—after windows, doors, walls, and ceilings. It is very difficult to clean floors of lead dust. Once you finish abating the floor, seal off the area until the final cleanup and a clearance can be done.

**Carpet removal
can cause high
levels of lead
dust to be
released.**



Staircases

Staircase abatement can be done in a number of ways. The entire staircase can be replaced—but this is extremely expensive and is generally not recommended. Parts of the staircase can be replaced, while other parts can be enclosed or encapsulated.

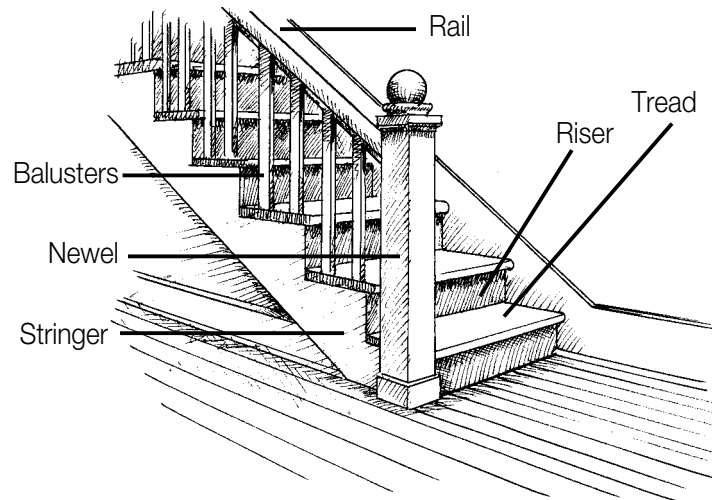

Staircase abatement

- **Stringers and newels**

Stringers and newels cannot be removed without taking out the whole staircase. This is very expensive. It is better to remove the lead-based paint on site or use an encapsulant that will hold up against impact.

- **Railings, newels, and balusters**

Railings, newels, and balusters can be treated with some encapsulants. However, the rail is a high friction area. An encapsulant may not work on the rail. The outside corners of the newel post and the top edge of the railing may need to be enclosed, wet planed, or chemically stripped.

In some cases, the balusters and rails can be removed and stripped off-site or replaced. The paint in between balusters must be removed on-site. As an **interim control** for square railing caps, you could wet-plane them across the top side.



- **Enclose treads and risers.**

A rubber tread with metal nosing works well. Rubber nosing may work, if it fits snugly on the nose of the stair and the stairs are not used very often.

- Enclose risers with thin plywood (such as luan plywood) or some other hard material. Whatever you use must fit snugly.
- Back caulk the edges of treads. Place treads, and nail or screw them down. Screw or nail the metal nosing on.

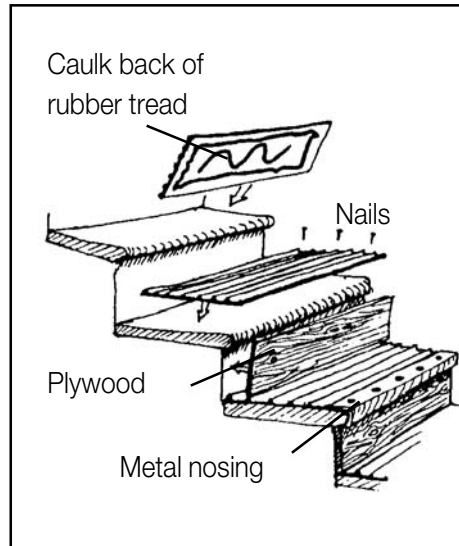

- **Enclose the whole railing system.**

You can enclose the railing cap, balusters, and newels with plywood or drywall. Then, cap the new system with a wooden rail. This solution changes the design of the room a lot. It also takes a long time, is a lot of work, and is expensive.

After abating the staircase

Once the staircase is abated, cover it with 6-mil poly. Staple down some type of non-slip material on top of the poly for worker safety. You can use cardboard stapled to the treads.



Lead-painted wooden porches are a serious lead hazard.

Porches

Wooden porches with lead-based paint are serious lead hazards because

- surfaces get worn down from weather changes;
- children spend a lot of time there;
- railings are at the right height for kids to put their mouths on.

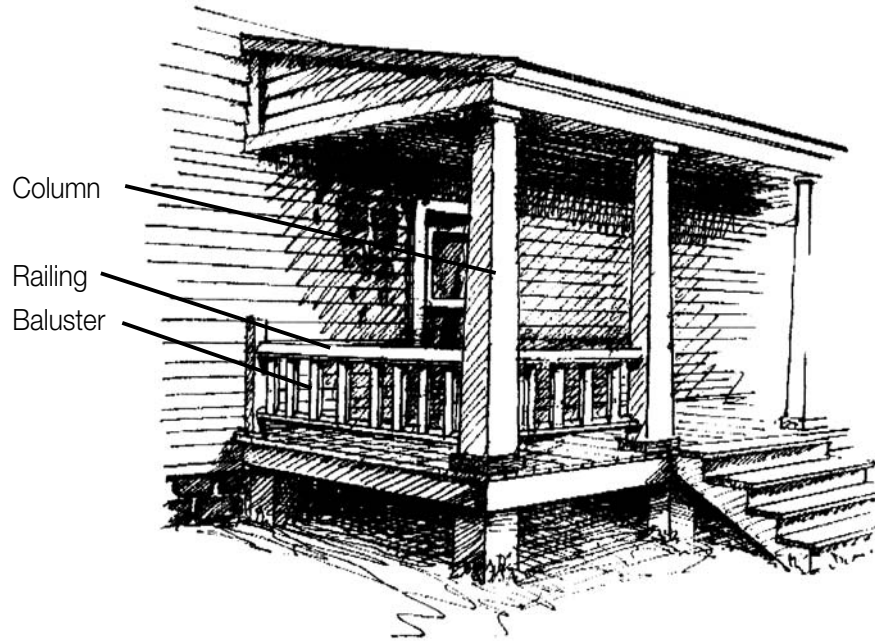

Porch floors should be replaced or enclosed. Use treated planks, treated tongue-and-groove, or exterior or marine-grade plywood. Make sure the floor slants down away from the house. The slant allows water to drain properly.

Balusters may be on-site stripped or encapsulated. They are often in such bad shape that they need to be replaced.

Rails can be replaced, stripped, or wet planed.

Structural columns can be wet scraped, encapsulated, or stripped.

Lattice (crisscrossed strips of wood or metal) should be replaced.

Ceilings may be enclosed with exterior grade plywood. Remember to back caulk around the edges.



Outside brick and cement

Abatement

Enclosing outside surfaces with a dust-tight material and vinyl or aluminum siding is often the method of choice. This method provides protection against weathering and increases the efficiency of the house. It also creates less waste than other abatement methods.

Vacuum blasting and contained water blasting may be allowed for outdoor work (your employer must check with the state or tribal agency responsible for regulating residential lead-based paint abatement). Chemical stripping can also be used. These methods are very costly and generate a lot of waste. Waste from water blasting and chemical stripping may be considered hazardous and must be disposed of properly.

When working on outside structures, setup is very important. You need to protect the soil, bushes, and plants, and the surrounding environment. Put 6-mil poly on the ground and seal it to the wall with duct tape or wood trim and masonry nails. There should be no gaps between poly and the building. You need to extend 10 feet of poly in every direction from the surface on which you are working. Place boards under the edge of the poly to create a curb. The curb directs the waste water into a low spot, where it can be pumped into a 55-gallon drum. A disposable tarp may be laid loosely over plants. Put weights around the edge of the tarp to keep it down. Keep all windows within 20 feet of the working surfaces closed, including windows of houses or buildings nearby.

If the outside work includes window treatment or replacement, then one layer of poly should be placed on the ground and extend at least 5 feet beyond the perimeter of the window being treated/replaced. Two layers of poly should be taped to the *interior* wall around the window(s) to prevent dust and debris from getting inside the house.

Clean and take down the entire outside setup at the end of each day. Lock up waste before leaving the work site.

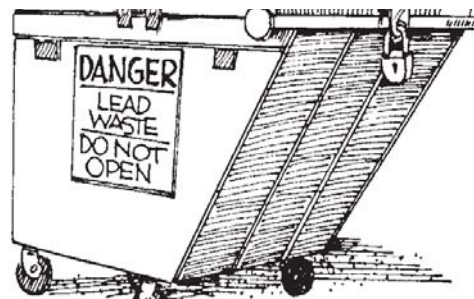

**Interim controls**

Wet scraping is sometimes used to remove loose lead-based paint from outside brick and cement structures. This is a very labor-intensive method. Masonry wet scraping should be done with maximum pressure to remove all paint that has separated from the substrate. Repaint with a high-grade masonry paint, or use an encapsulant recommended for masonry application.



Key facts for Appendix A

 The four abatement methods used in a home are

- replacement
- enclosure
- encapsulation
- paint removal

 Replacing lead-painted windows, doors and woodwork is a good way to reduce lead hazards.

Back-caulk **and** nail (or screw in) replacement parts when you install them.

 Do not use encapsulants on structurally damaged walls or walls that are separating from the substrate.

 Enclosure is often used for lead-painted floors and ceilings.

Create a dust-tight seal when you enclose a surface.

Back-caulk **and** nail (or screw in) enclosure materials.

 When working on outside structures, setup is very important.

 Interim controls are only temporary solutions.

They are actions you can take to reduce lead dust levels until you do an abatement.

Interim controls should not take the place of abatement.

Interim controls may not be allowed in your state or local area. Check your state and local laws.



For more information

These publications have more information on the topics covered in this appendix. Your instructor will have a copy of some of the publications. You can order your own copies by calling 1-800-424-LEAD.

EPA, *Regulatory Status of Waste Generated by Contractors and Residents from Lead-Based Paint Activities Conducted in Households*, Interpretive Memorandum (July 2000).

EPA, *Lead: Requirements for Hazard Education Before Renovation of Target Housing; Final Rule*; 40 CFR Part 745 (June 1998).

*EPA, *Lead: Requirements for Lead-Based Paint Activities in Target Housing and Child-Occupied Facilities*; 40 CFR Part 745 (August 1996).

EPA, HUD, and CDC, *Lead Paint Safety: A Field Guide for Painting, Home Maintenance, and Renovation Work* (June 1999).

EPA, HUD, and CPSC, *Protect Your Family From Lead in Your Home* (June 2003).

*HUD, *Requirements for Notification, Evaluation and Reduction of Lead-Based Paint Hazards in Federally Owned Residential Property and Housing Receiving Federal Assistance; Final Rule* (September 1999).

*HUD, *Guidelines for the Evaluation and Control of Lead-Based Paint Hazards in Housing* (June 1995).

*OSHA, *Interim Final Lead in Construction Standard*, 29 CFR 1926.62 (May 1993).

Society for Occupational and Environmental Health, *Protecting Workers and Their Communities from Lead Hazards: A Guide for Protective Work Practices and Effective Worker Training* (1993).